

Spent (p)					
Had left (p)					

LP 111/2

a)

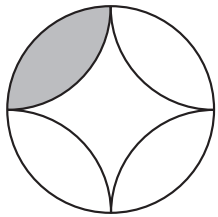

b)

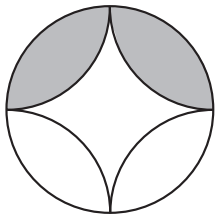

c)

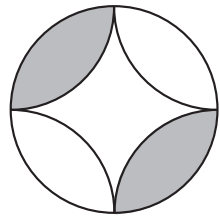

d)

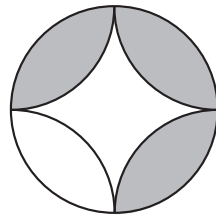

e)

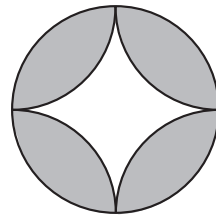

f)

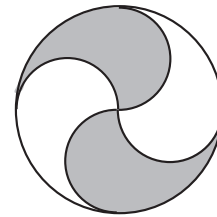

g)

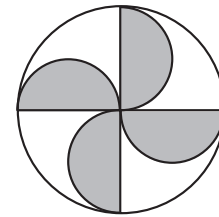

h)

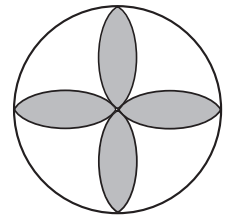

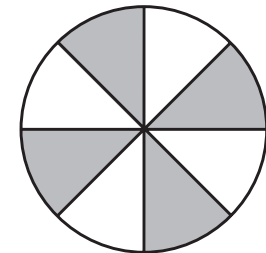
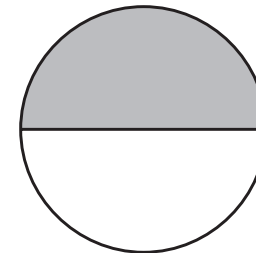
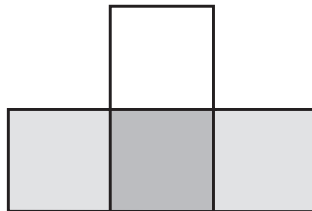
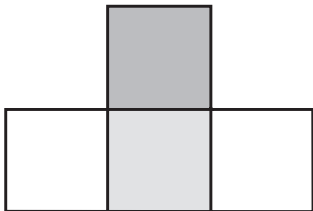
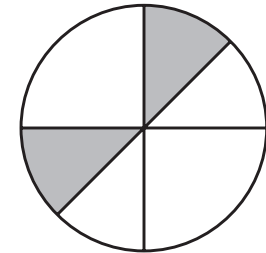
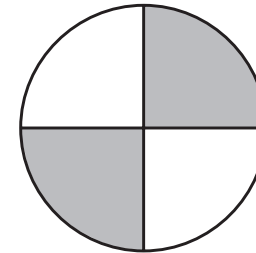
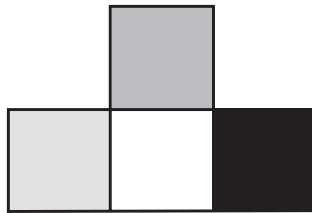
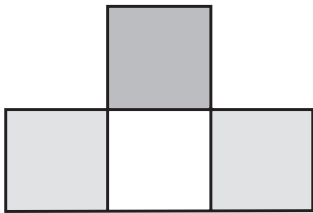
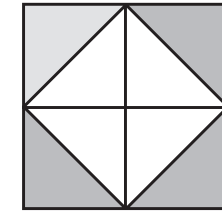
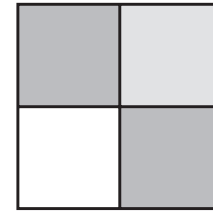
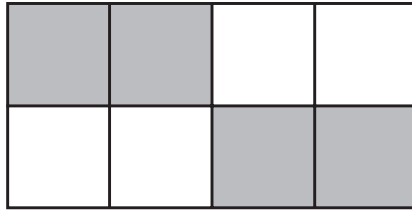
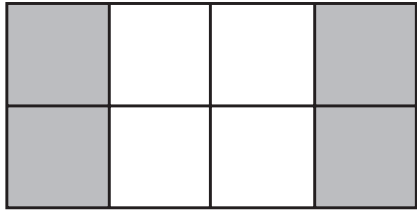
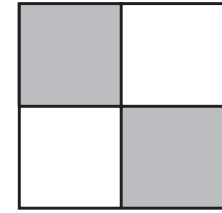
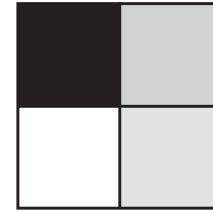
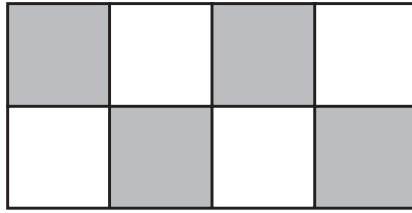
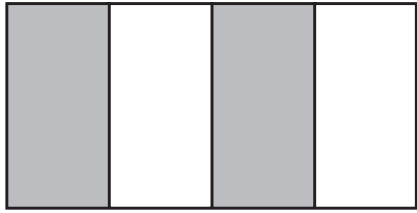

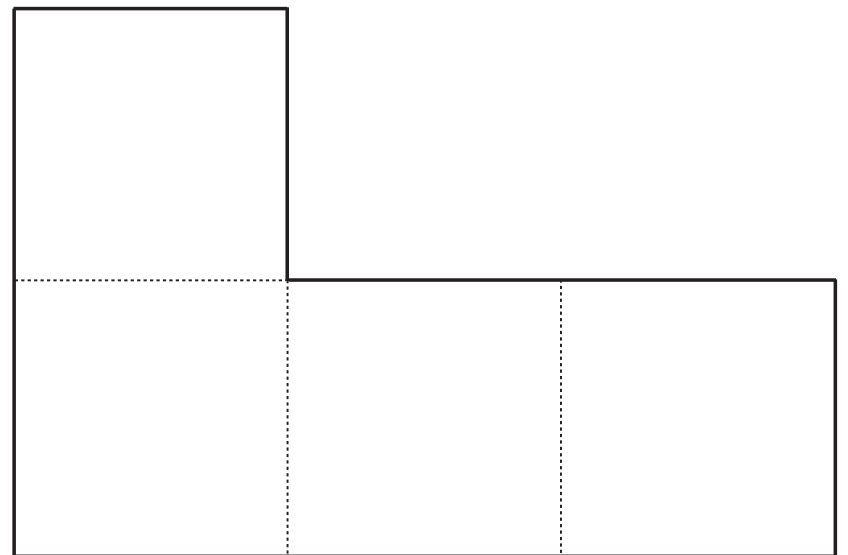
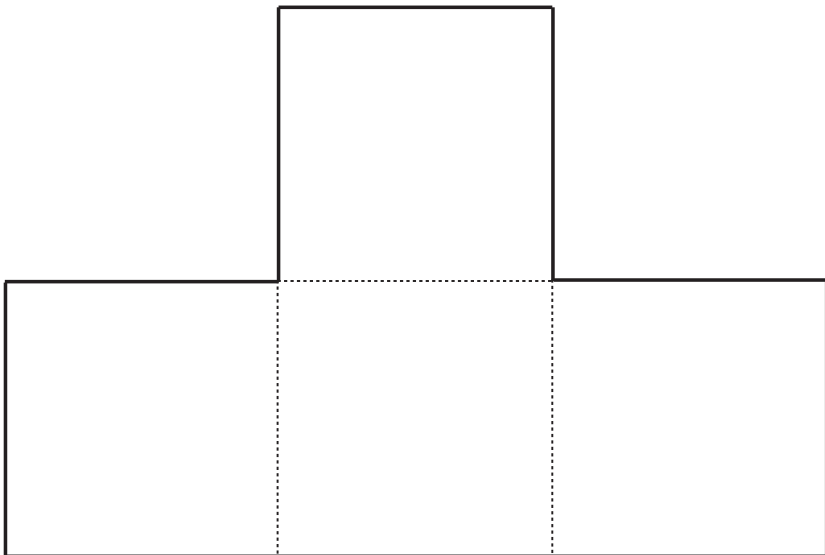
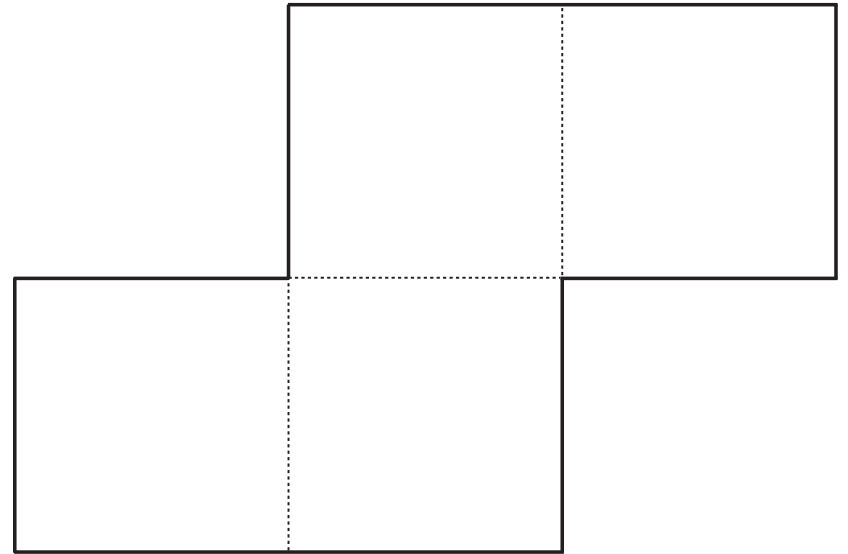
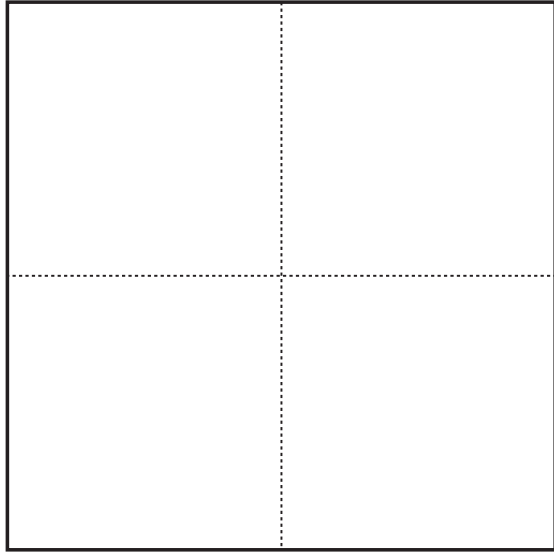

a)

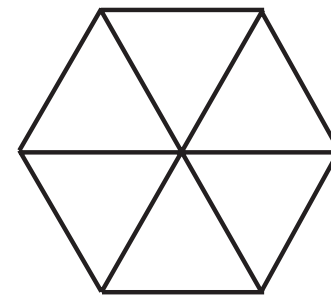
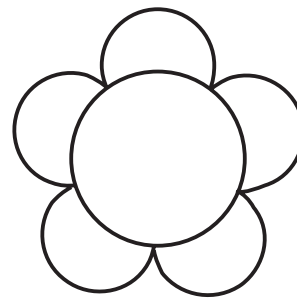
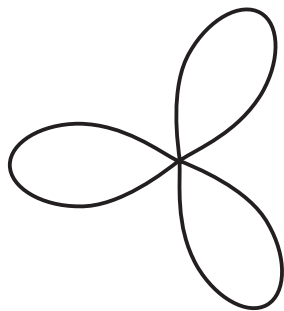
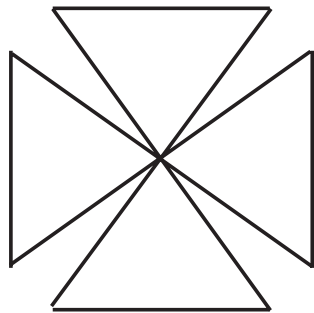

b)

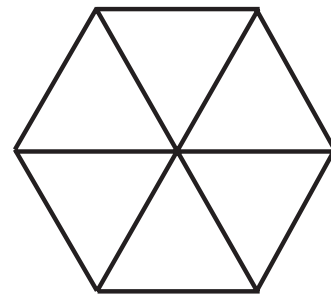
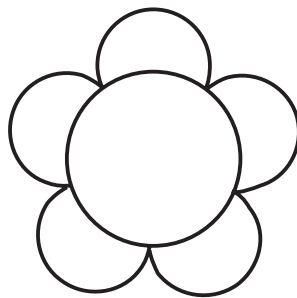
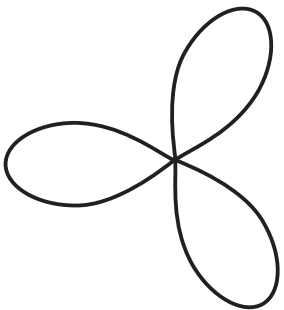
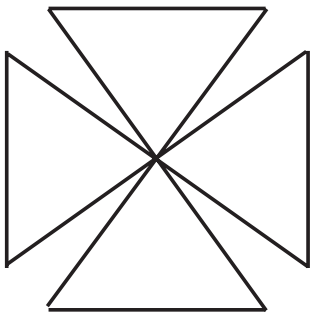

c)

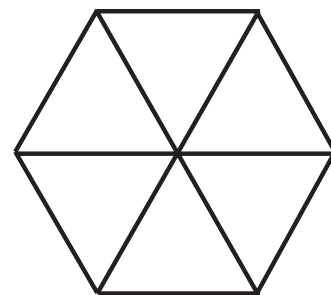
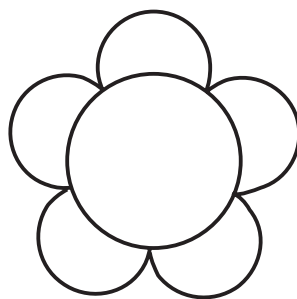
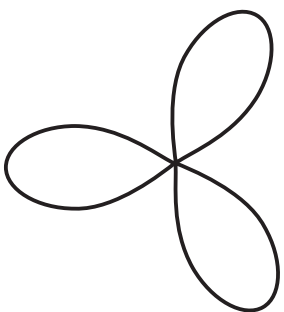
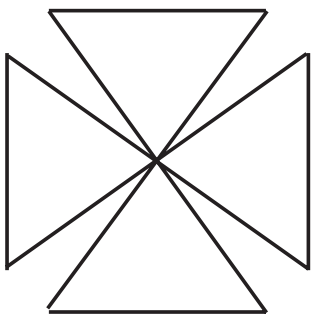

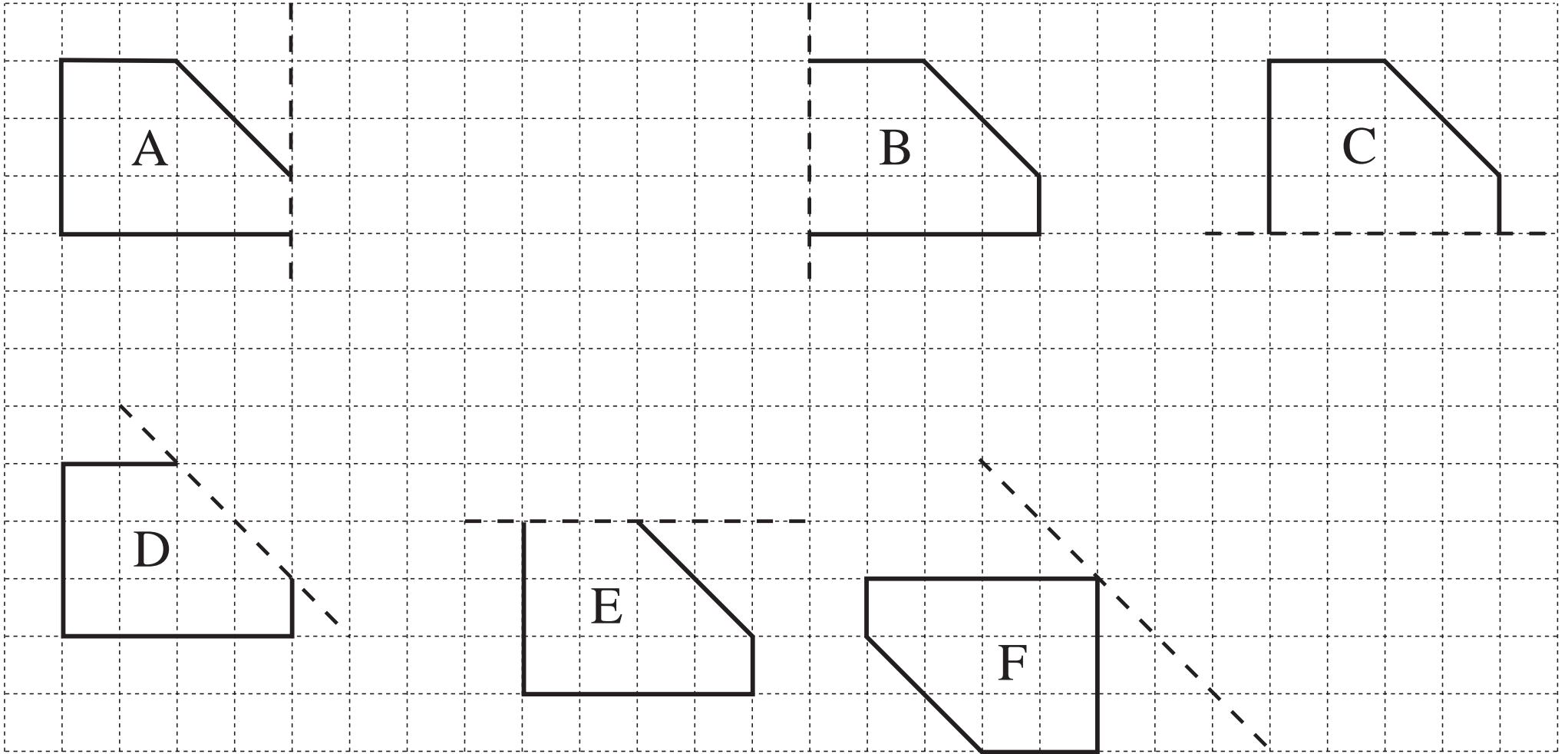

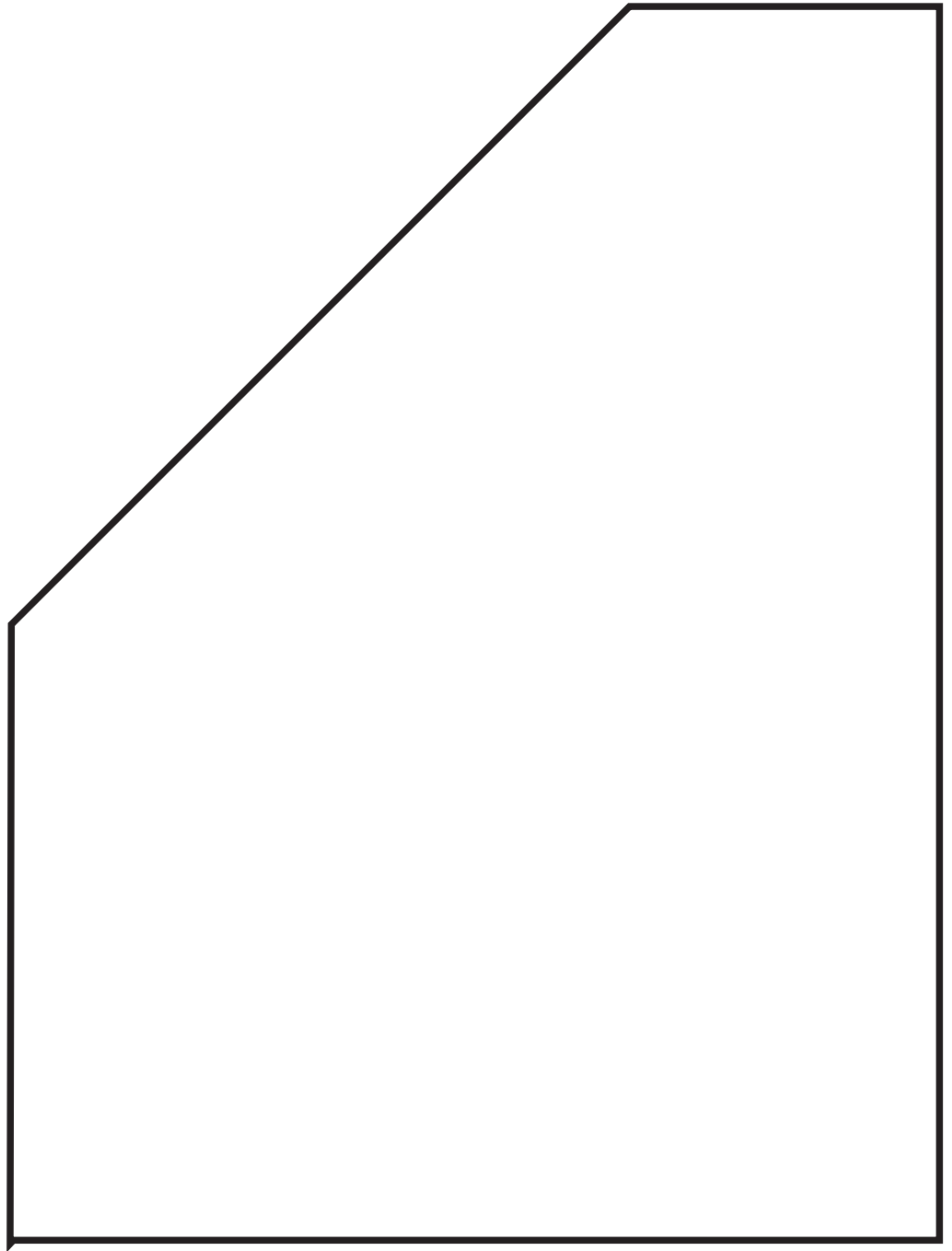
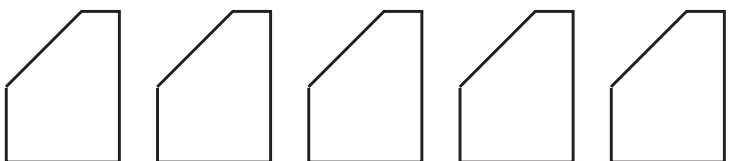
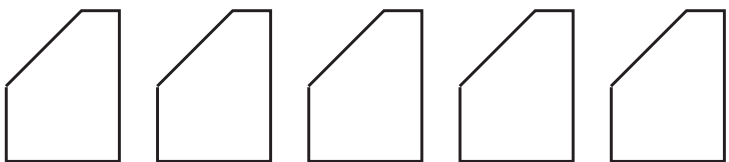
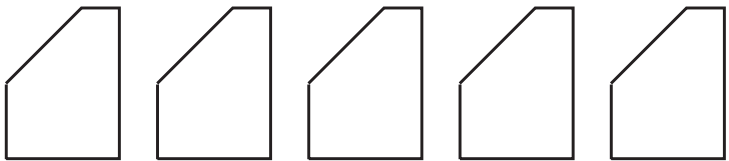
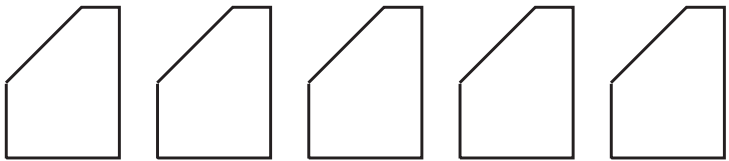
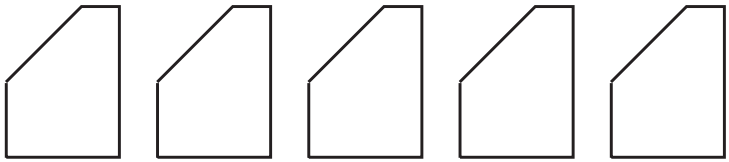
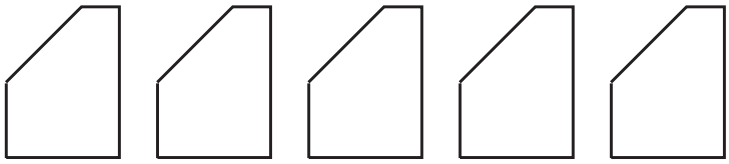

a)

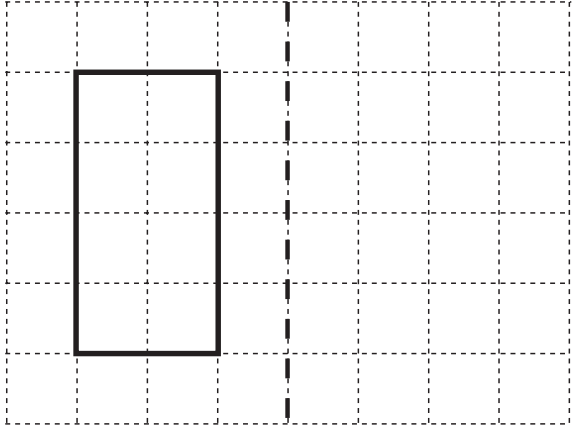

b)

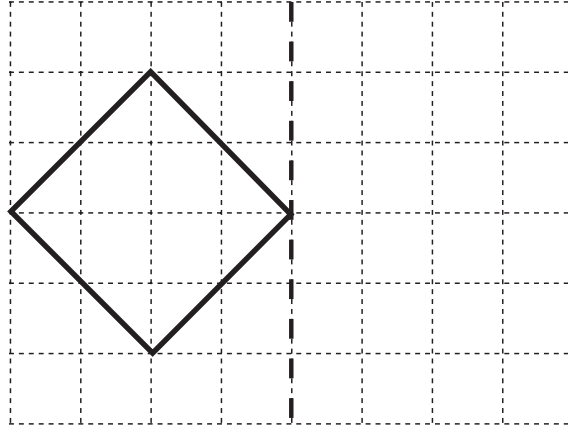

c)

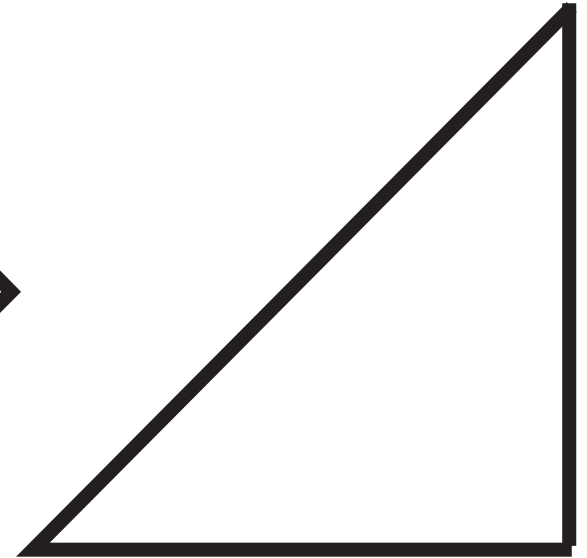
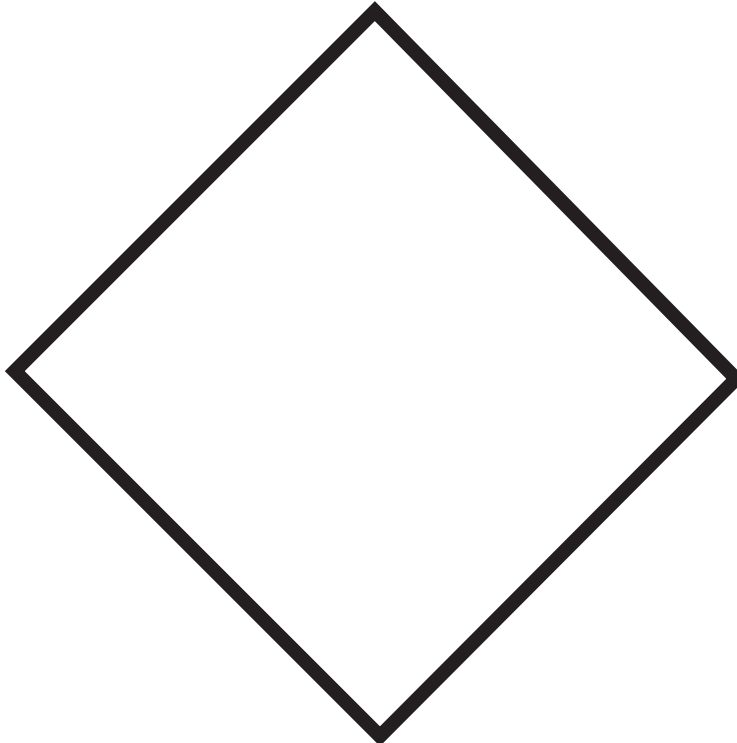
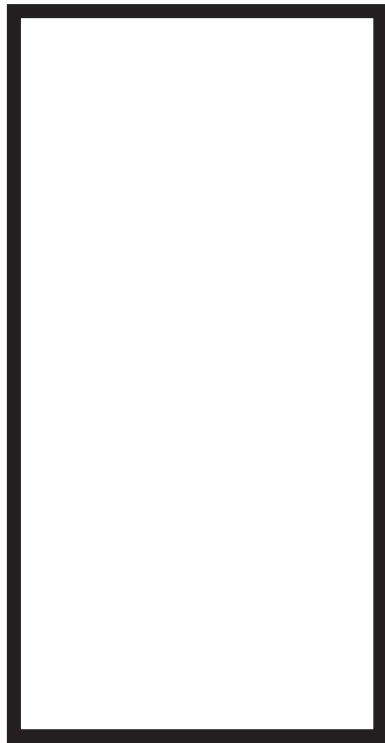
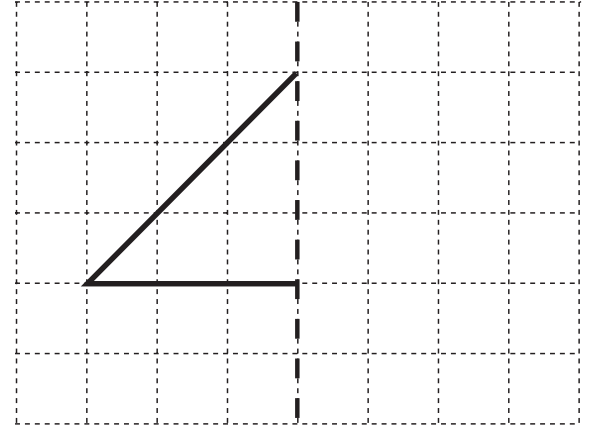

<i>C</i>	541			1014	
<i>J</i>		541			1014
<i>L</i>			541		1014

LP 112/1

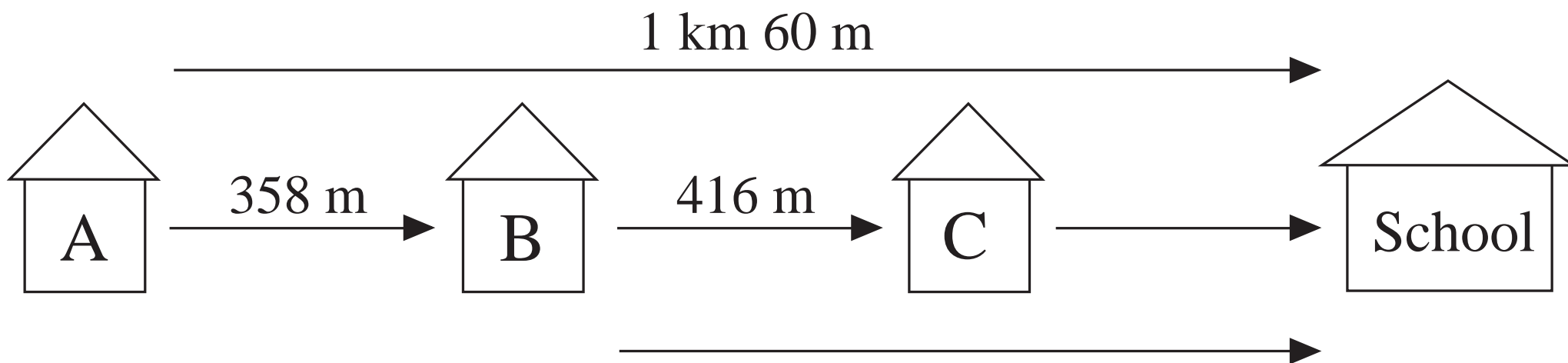

LP 112/2

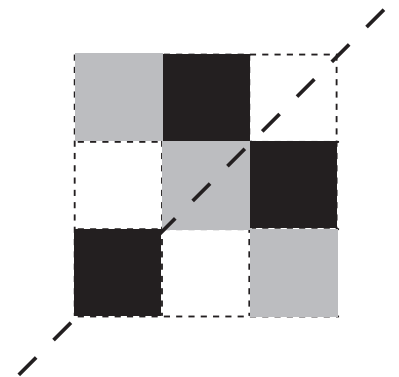
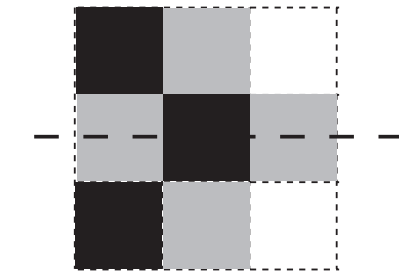
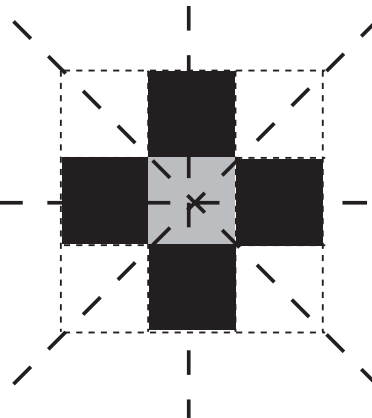
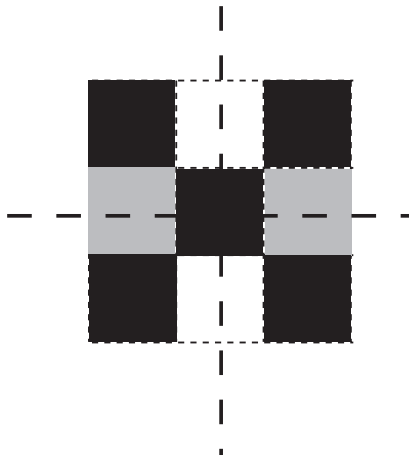
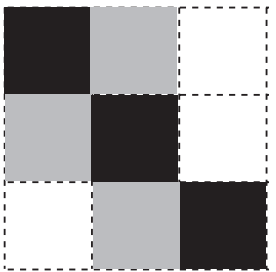
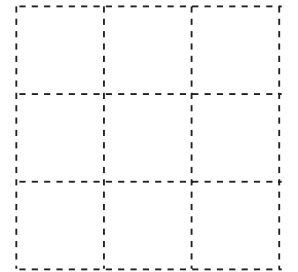
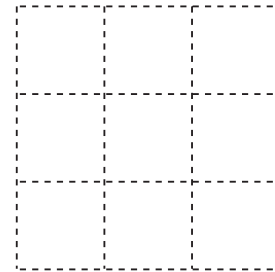
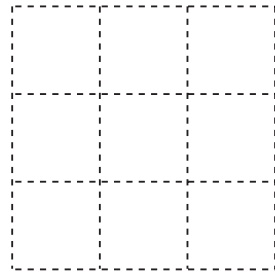
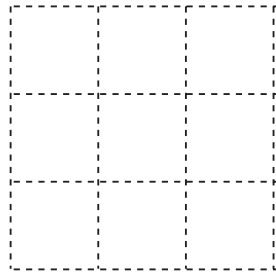
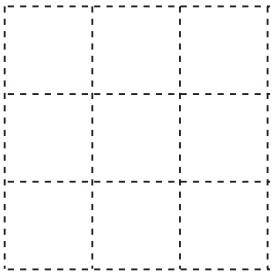
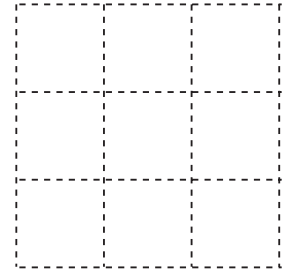
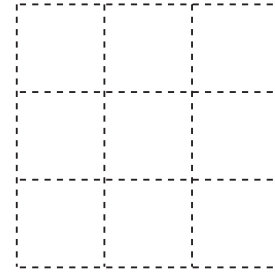
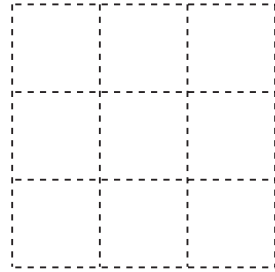
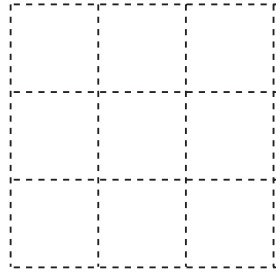
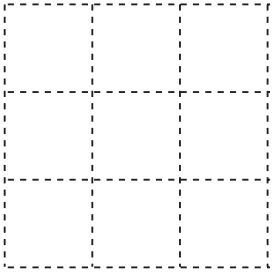
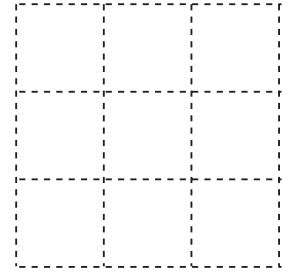
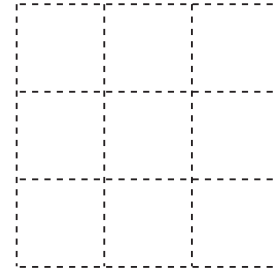
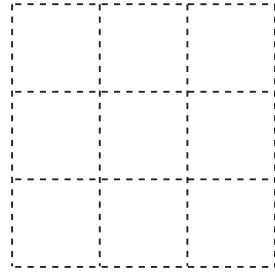
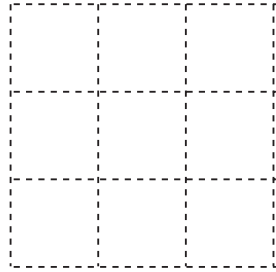
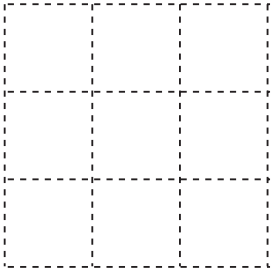

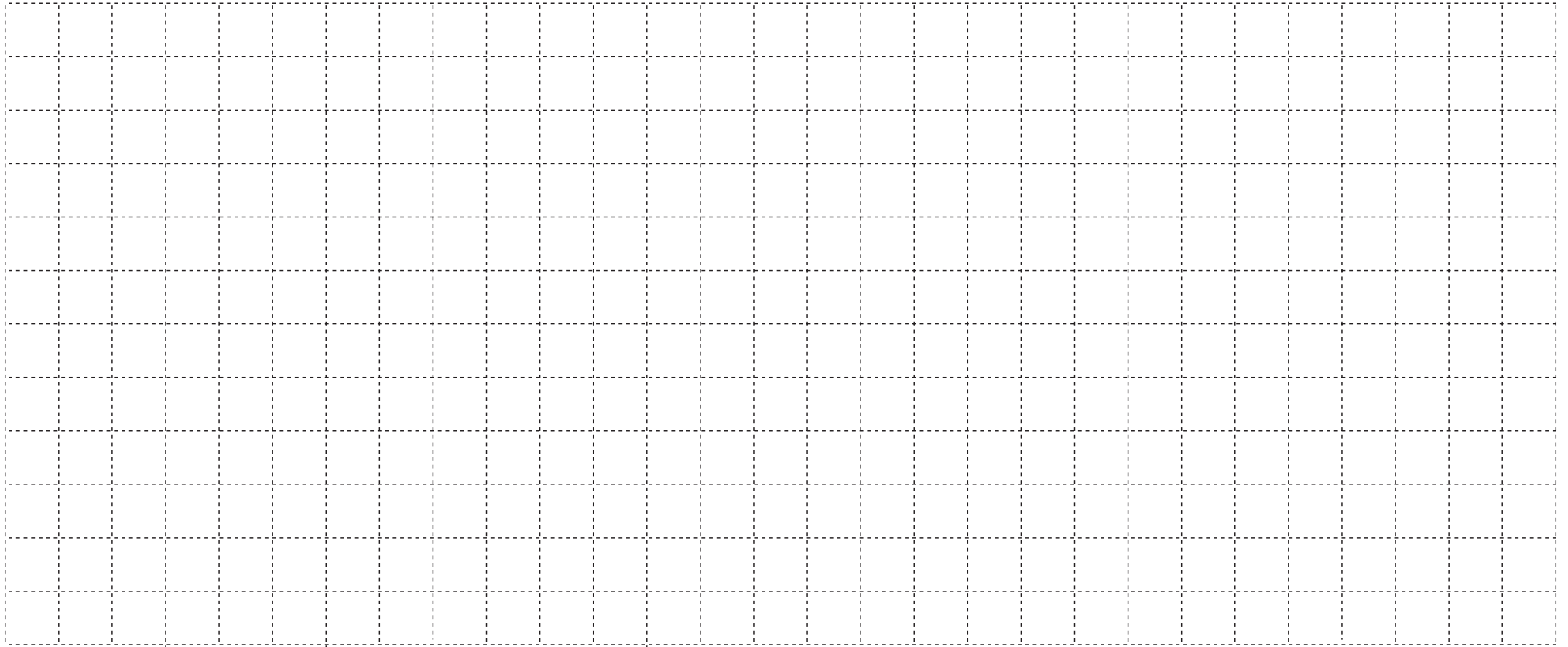

a)

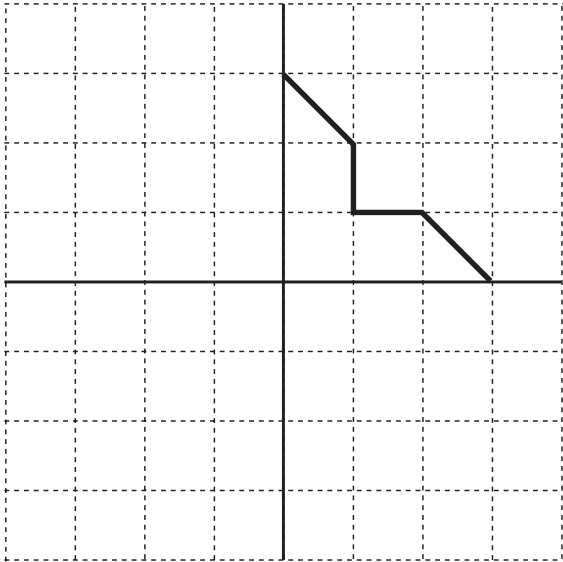

b)

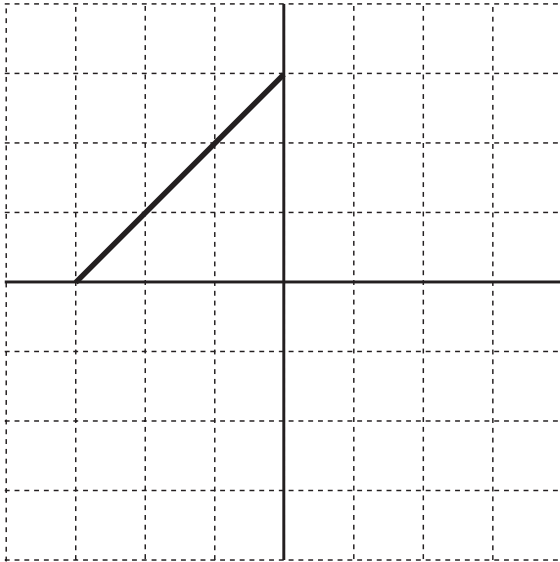

c)

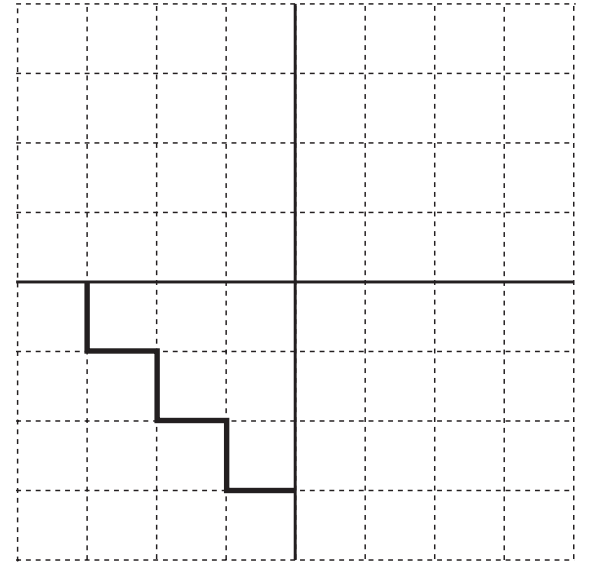

d)

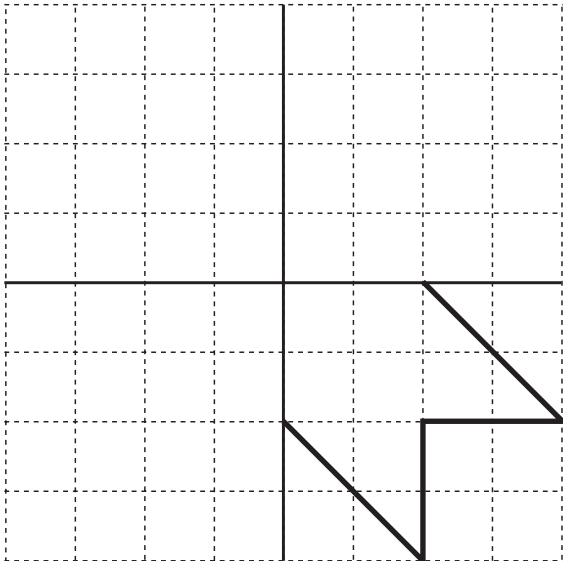

e)

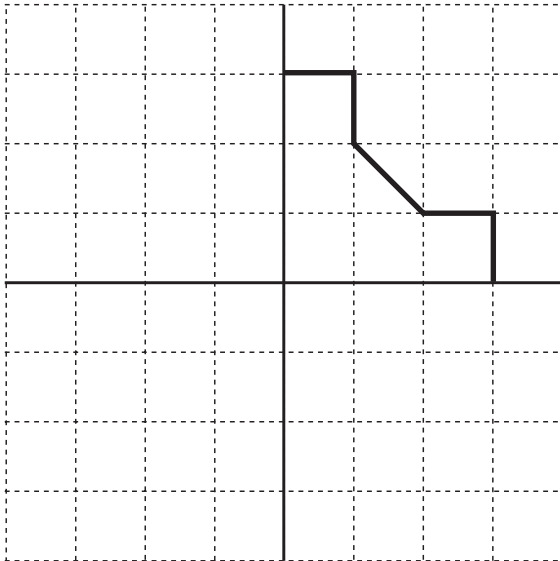

f)

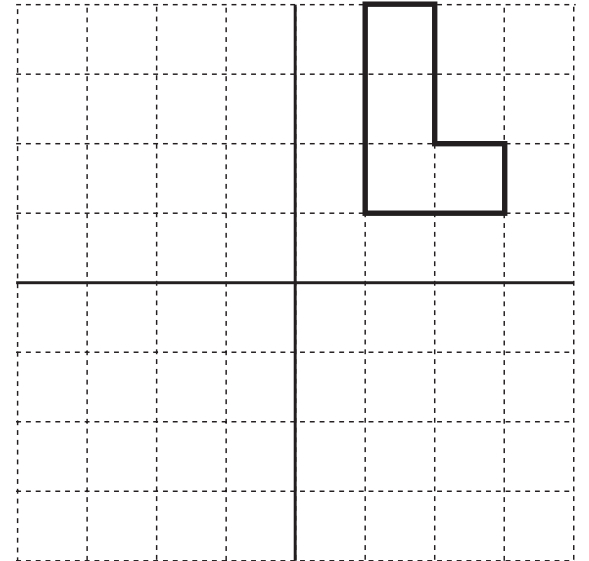

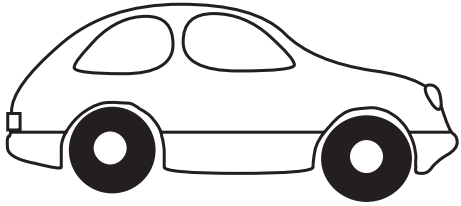

£6.75



£3.32

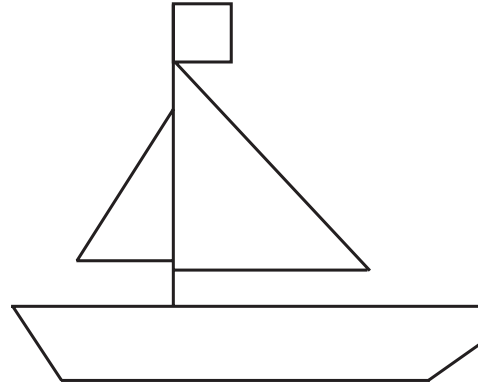

£8.54

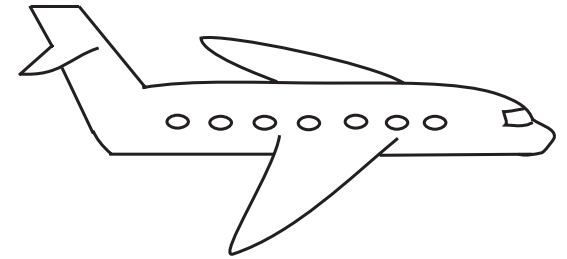

£4.99

LP 113/1

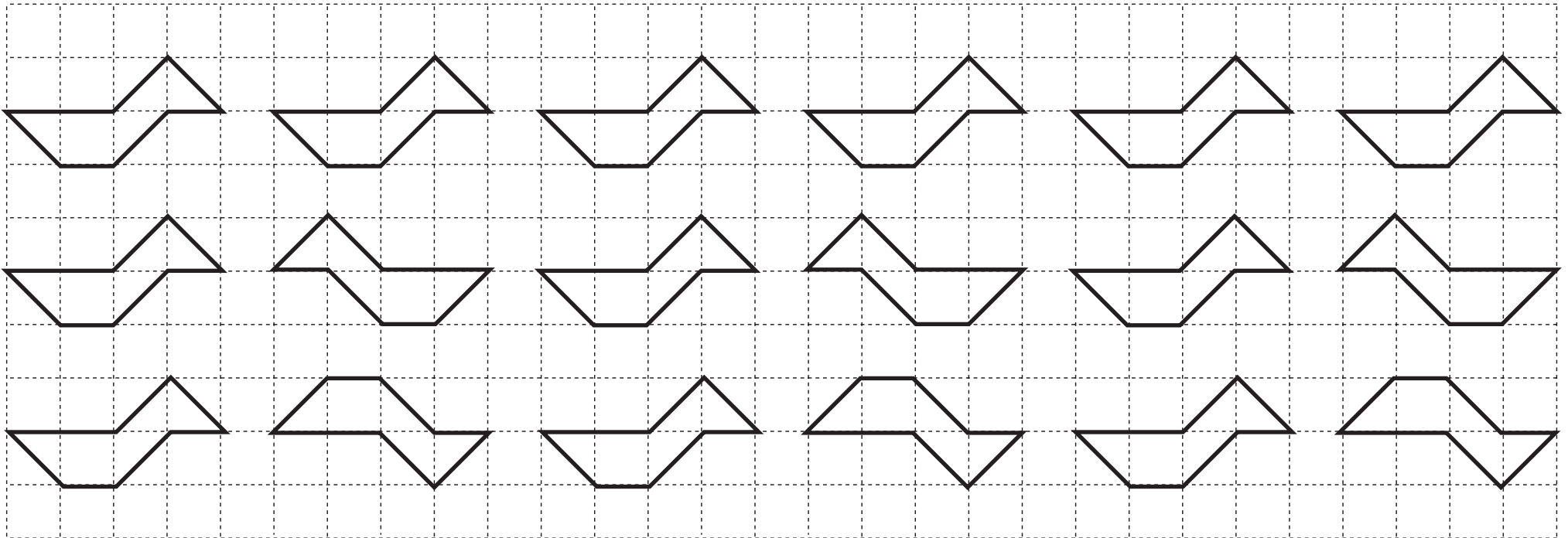

LP 113/5

a)

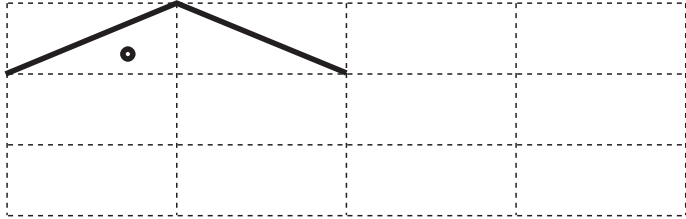

b)

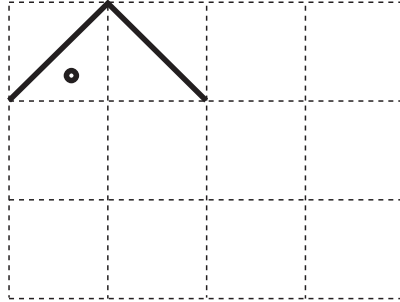

c)

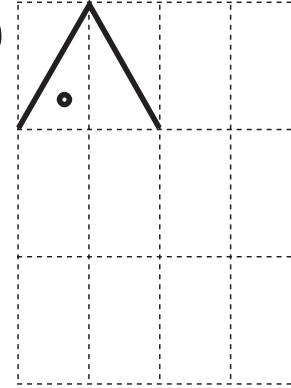

d)

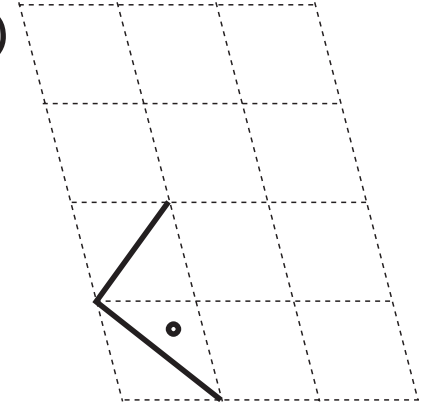

LP 113/7

a)

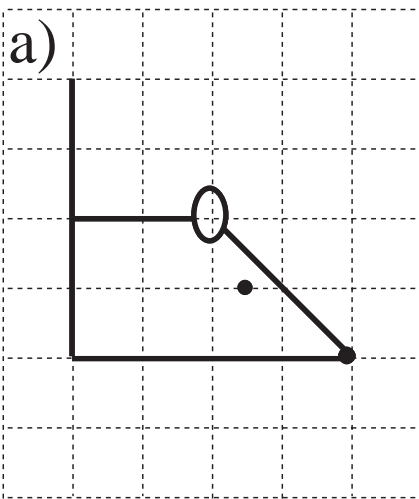

b)

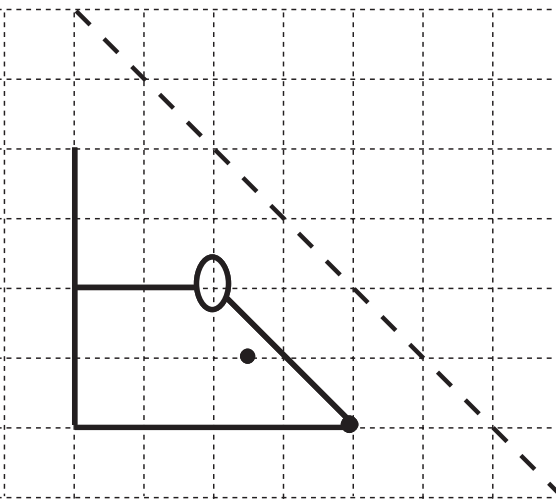

c)

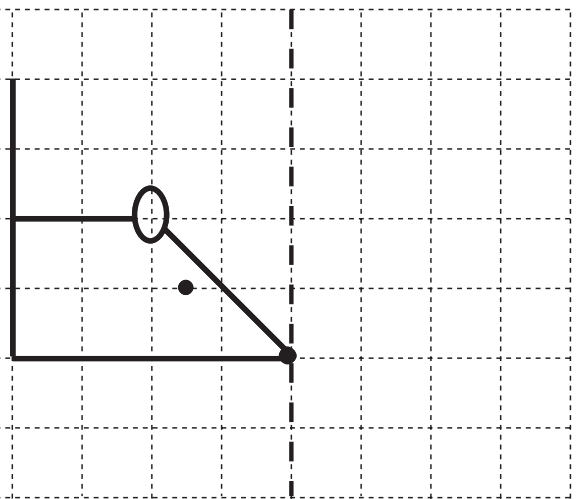

LP 113/8a

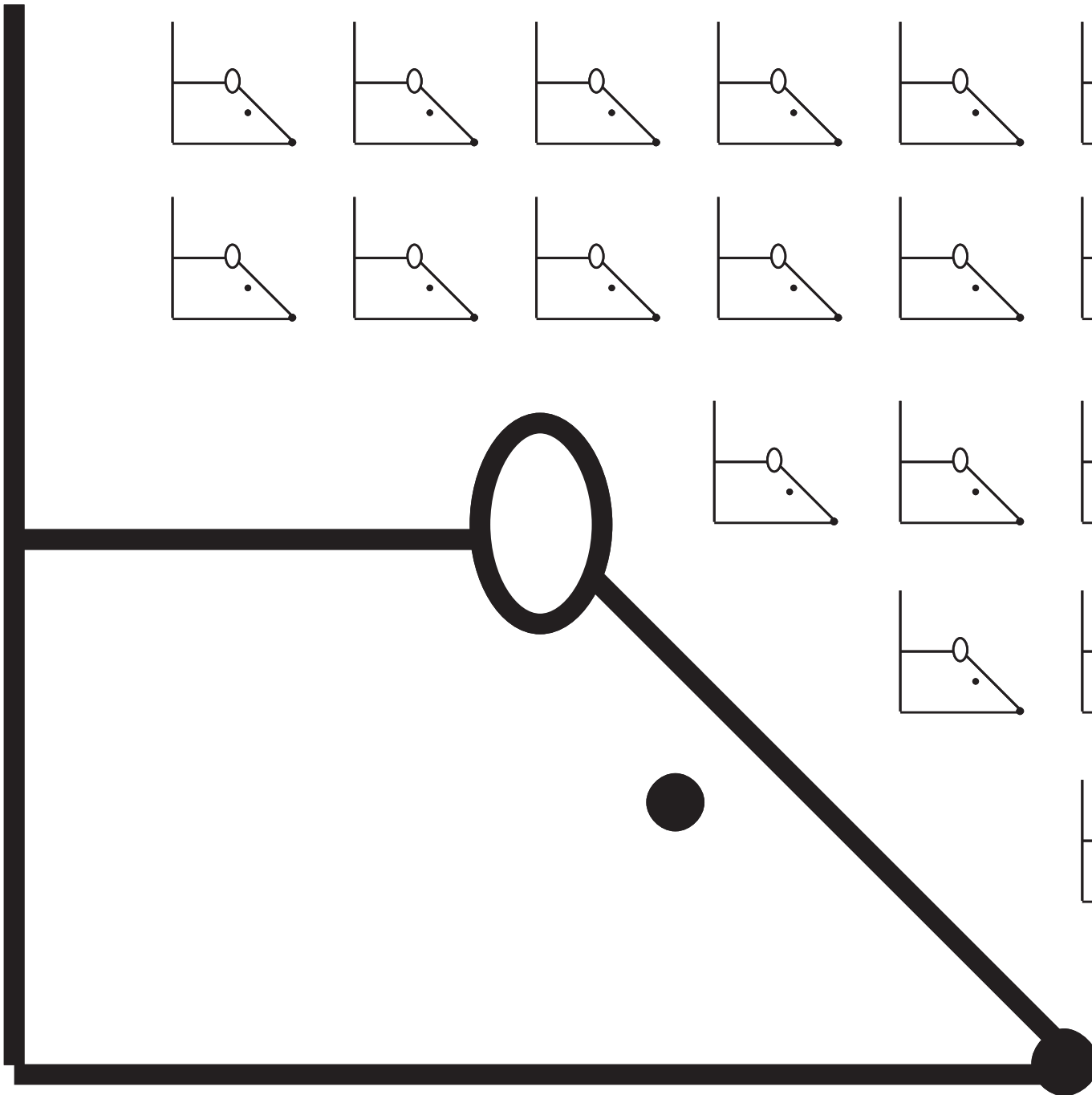
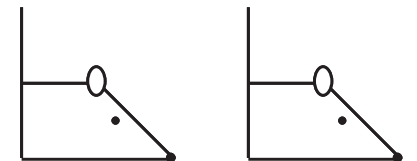
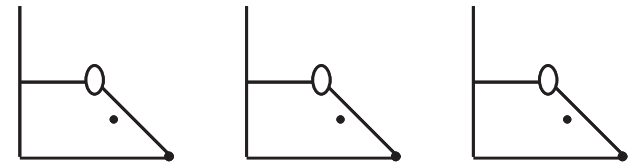
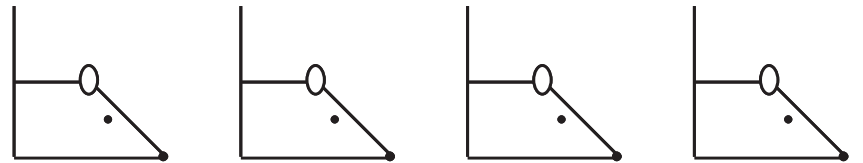
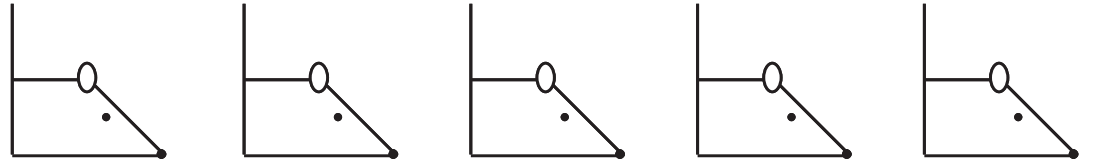
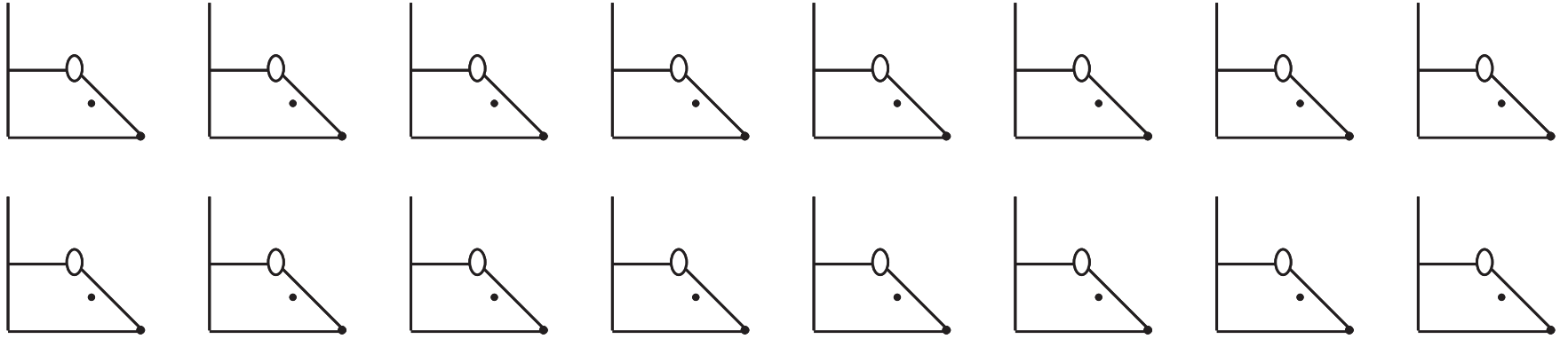

A

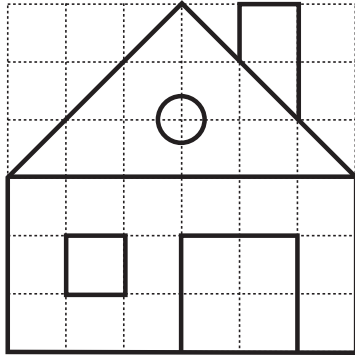

B

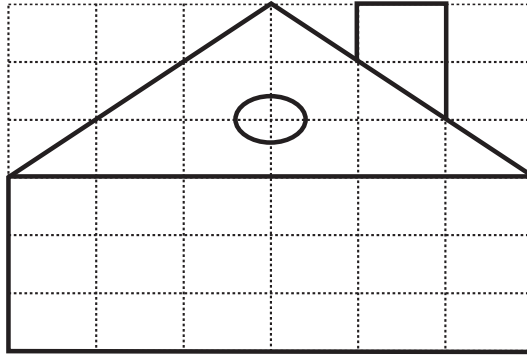

C

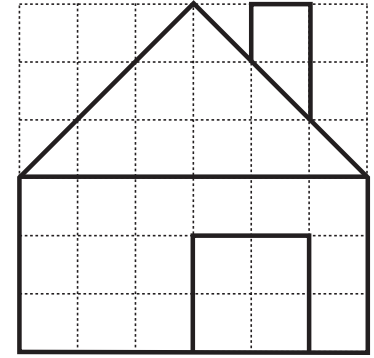

D

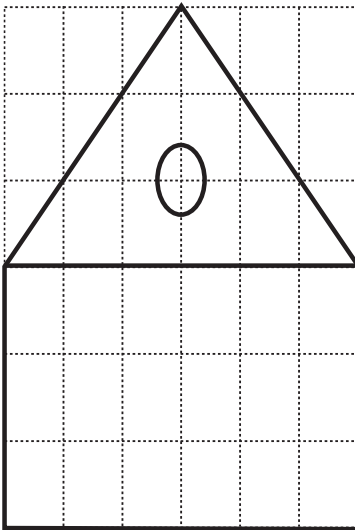

E

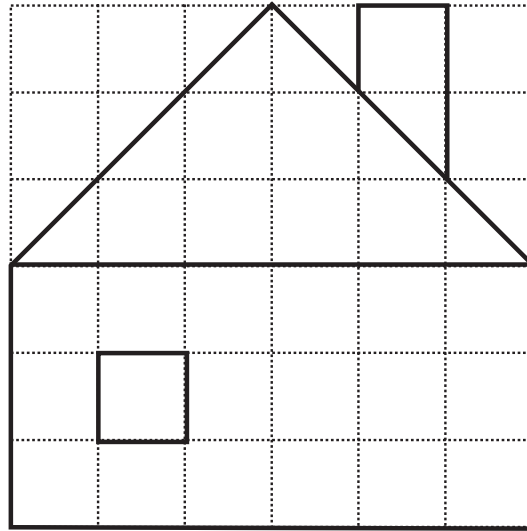

F

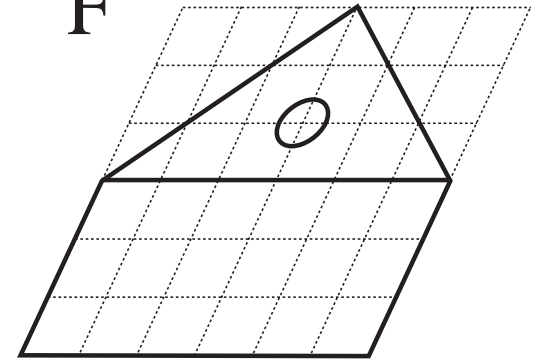

G

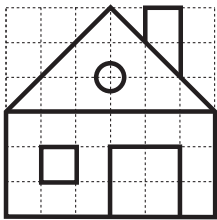

H

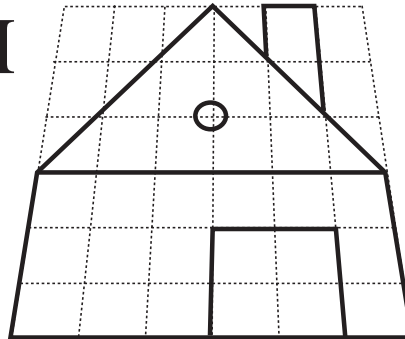

I

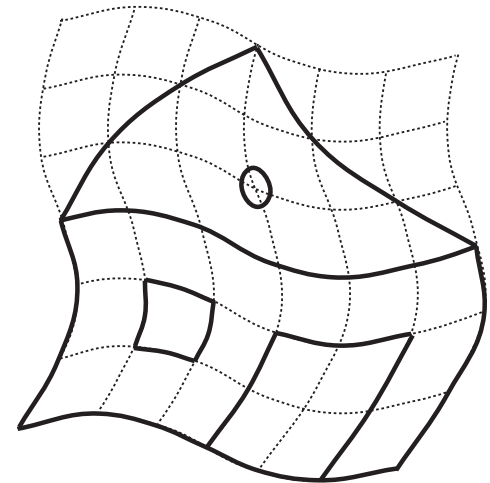

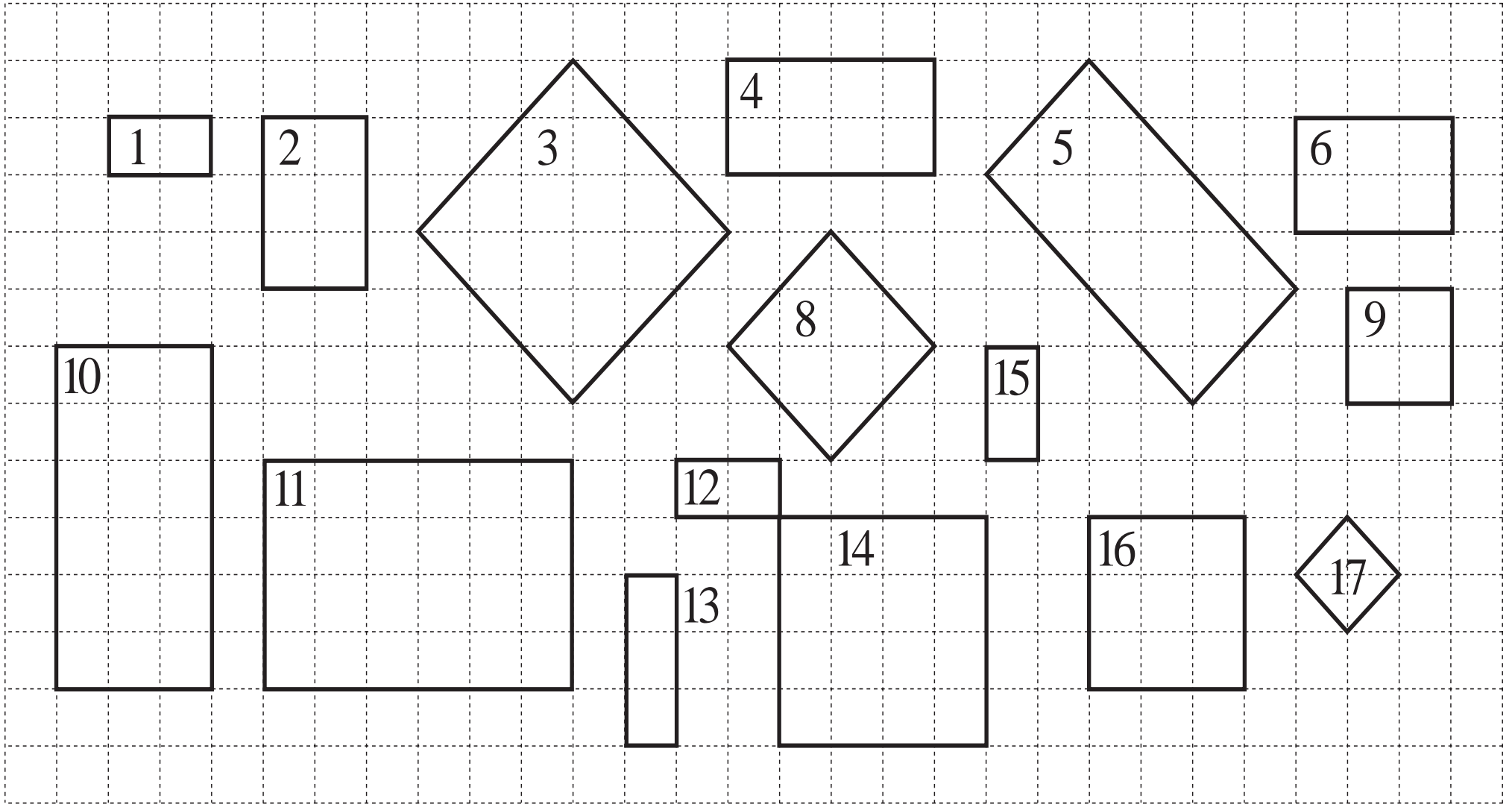

4 m

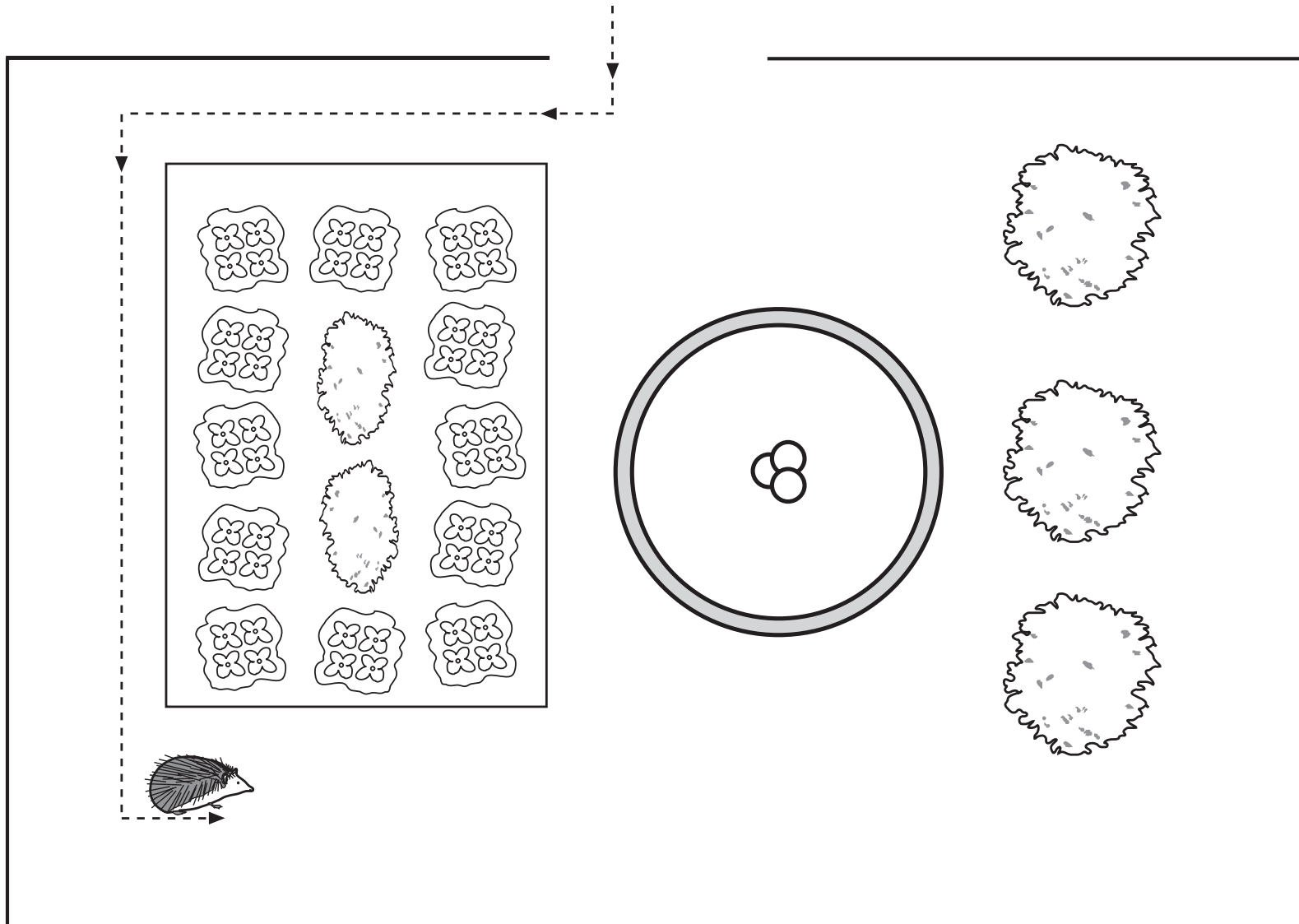
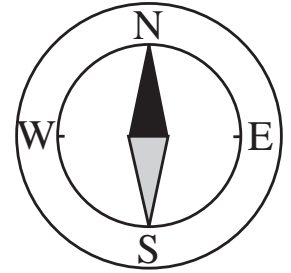

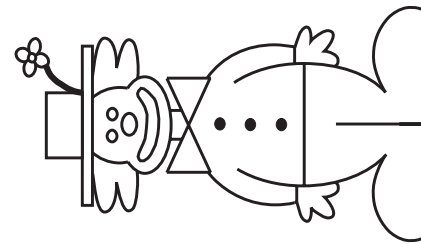
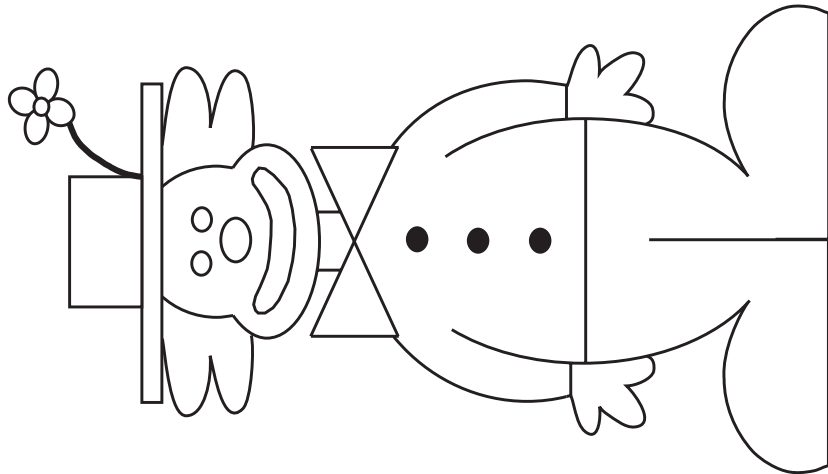
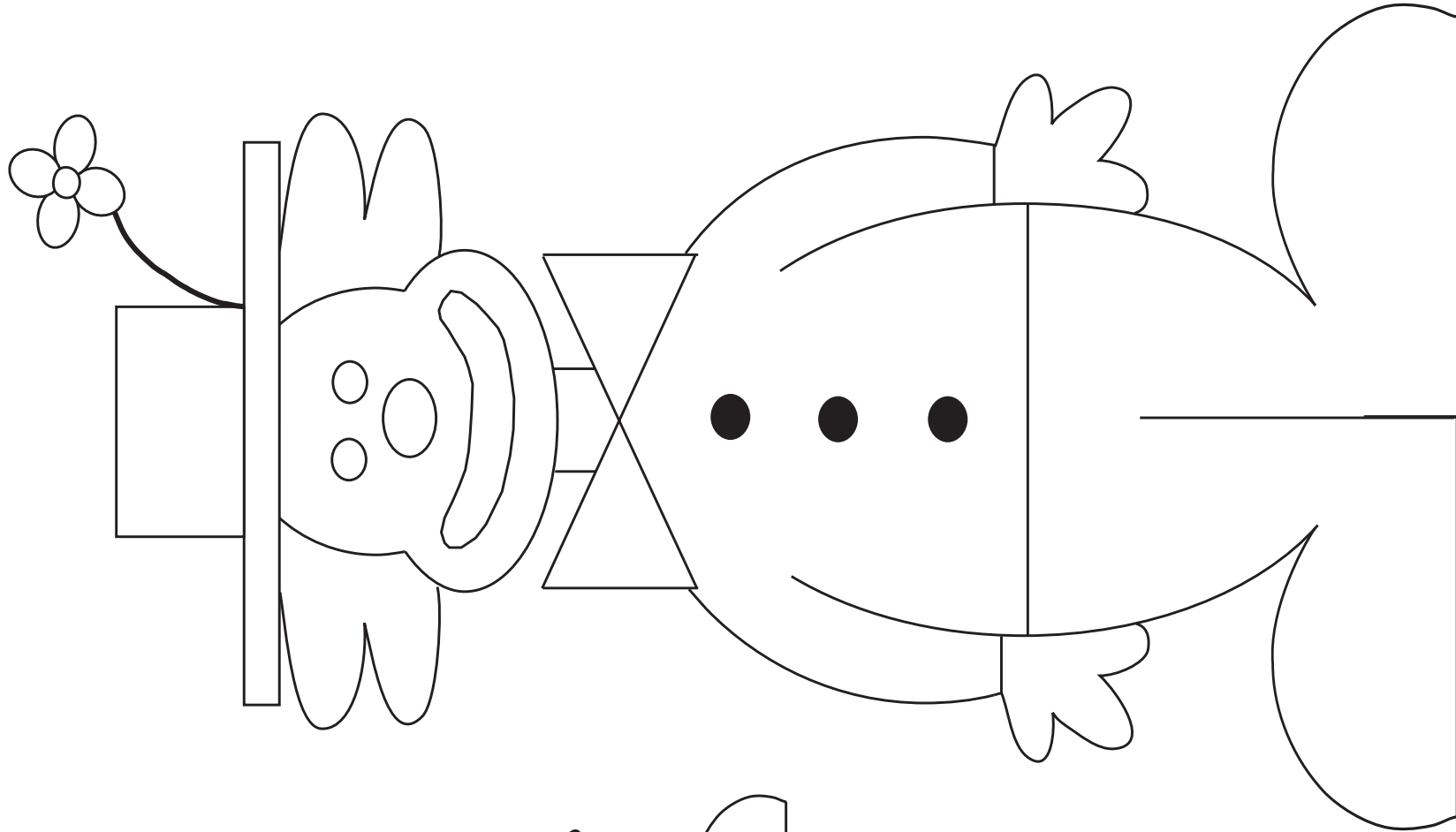

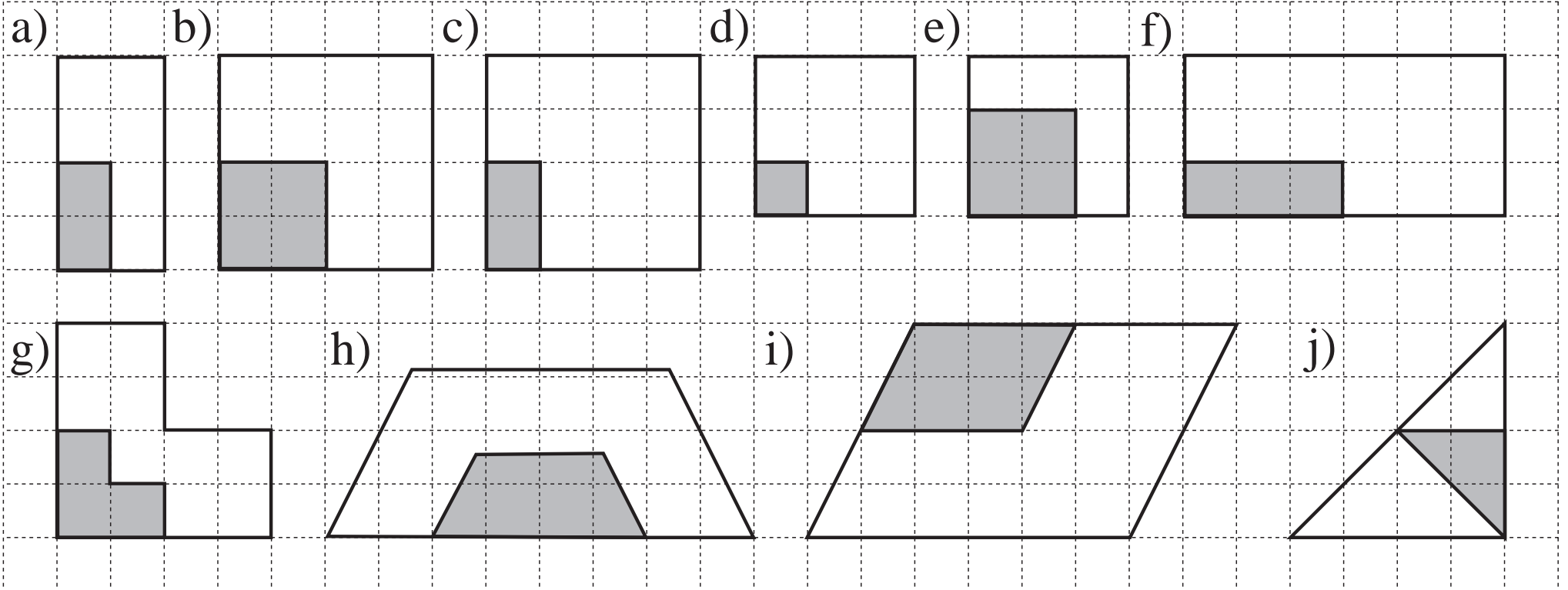

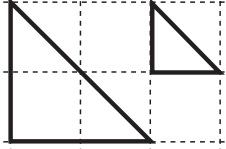
a) 

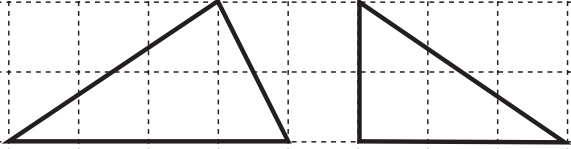
b) 

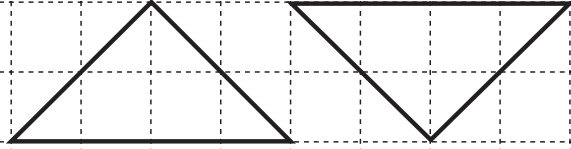
c) 

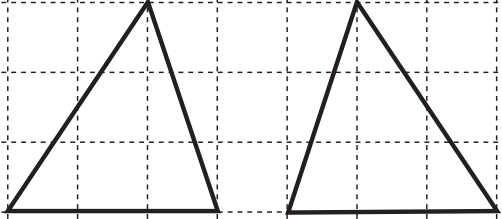
d) 

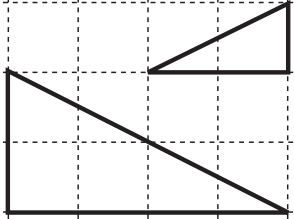
e) 

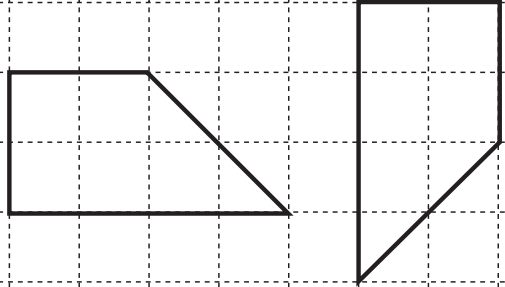
f) 

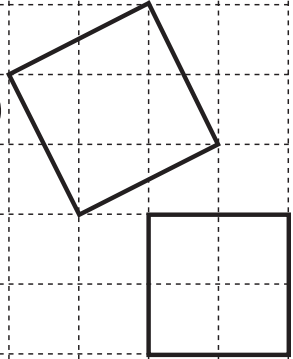
g) 

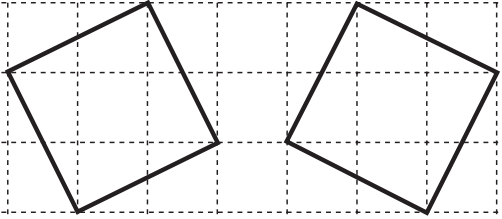
h) 

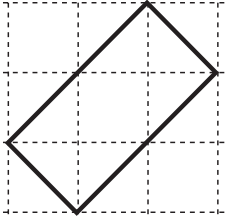
i) 

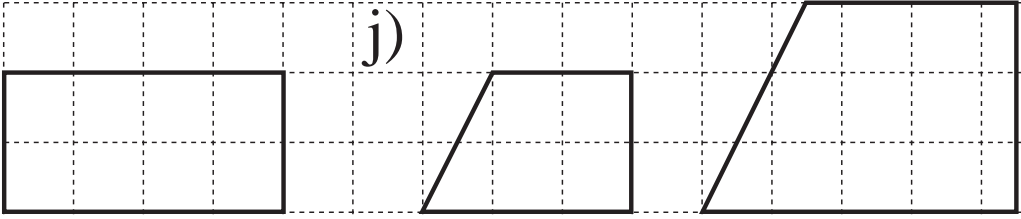
j) 

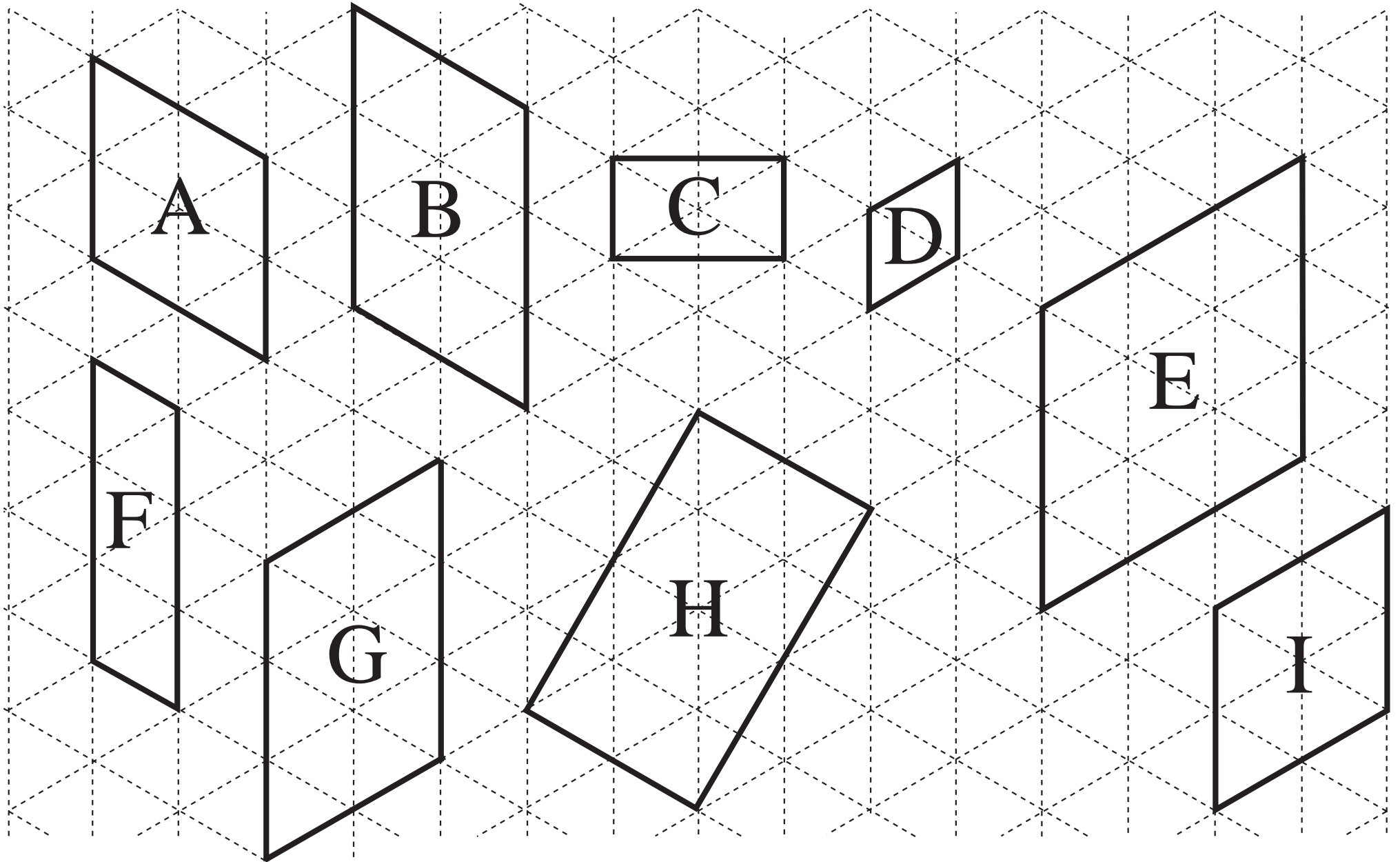

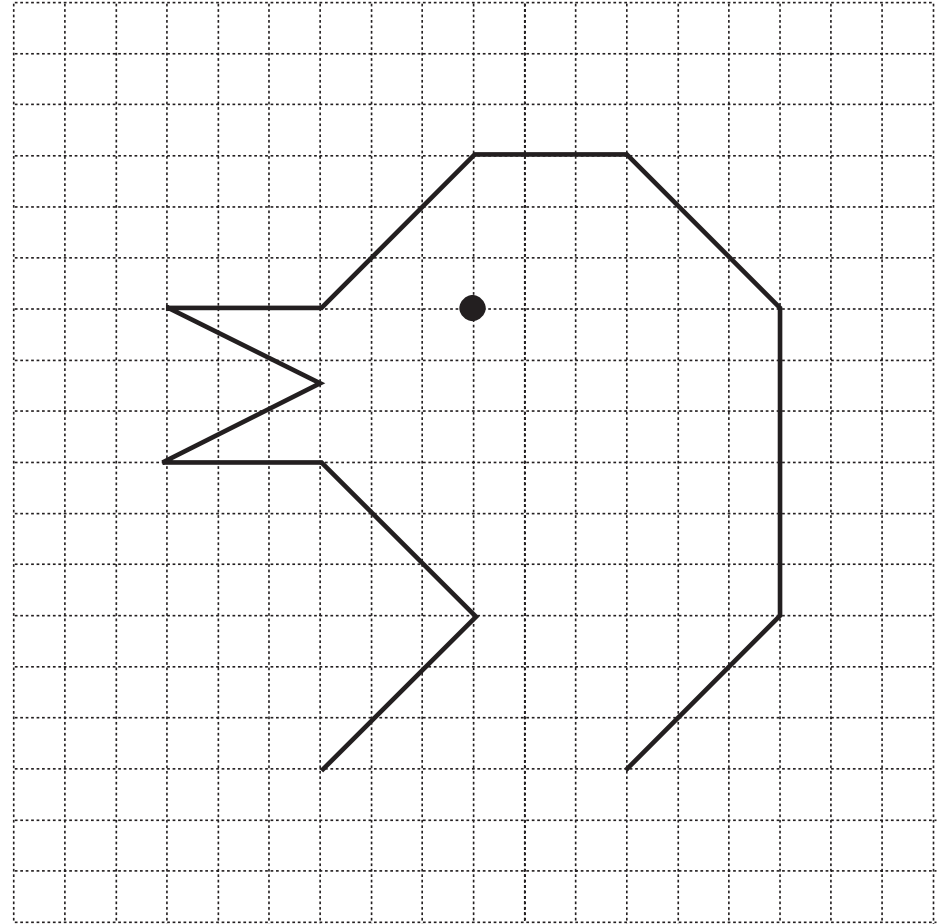
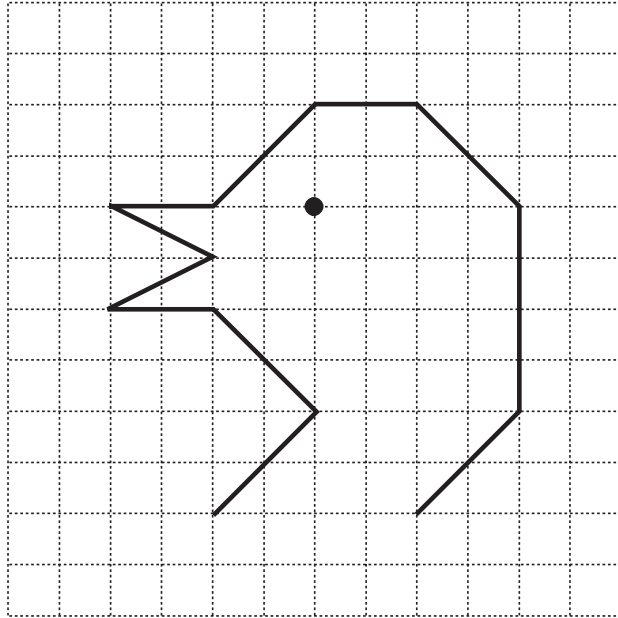
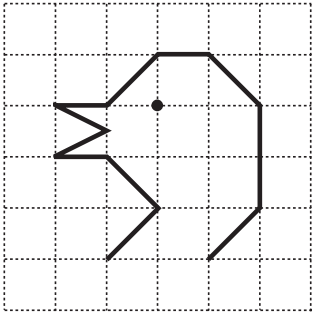

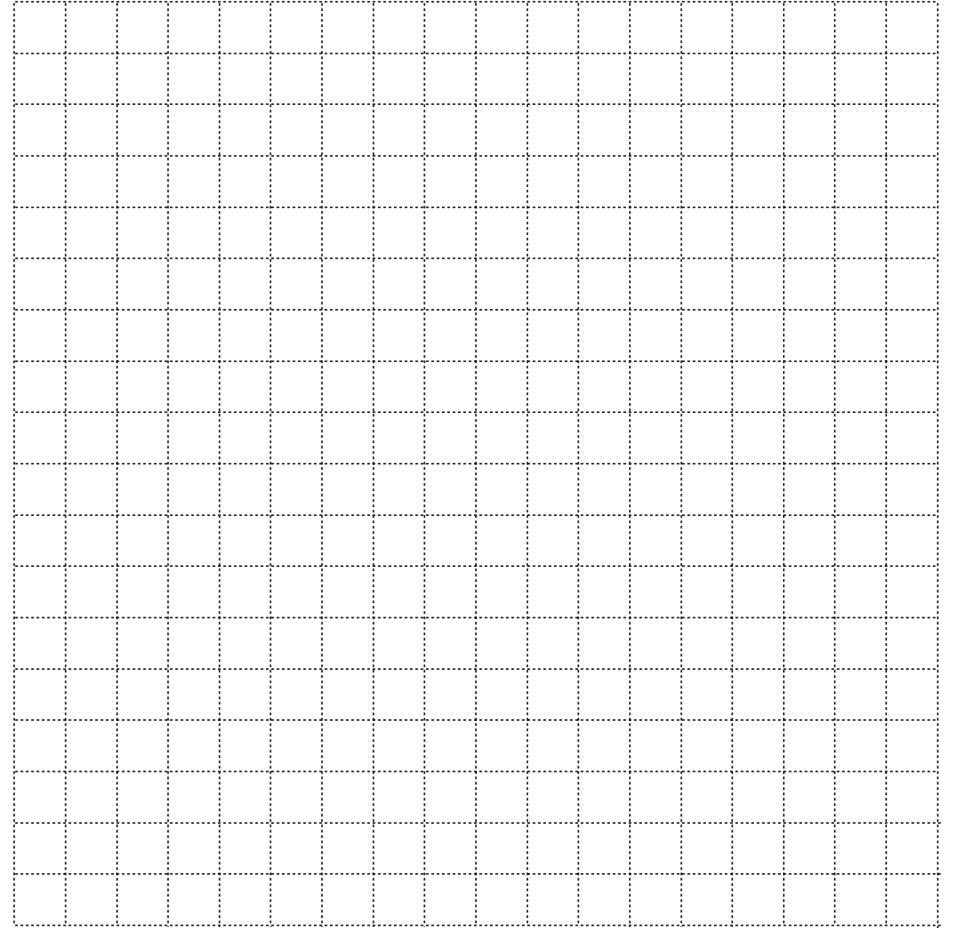
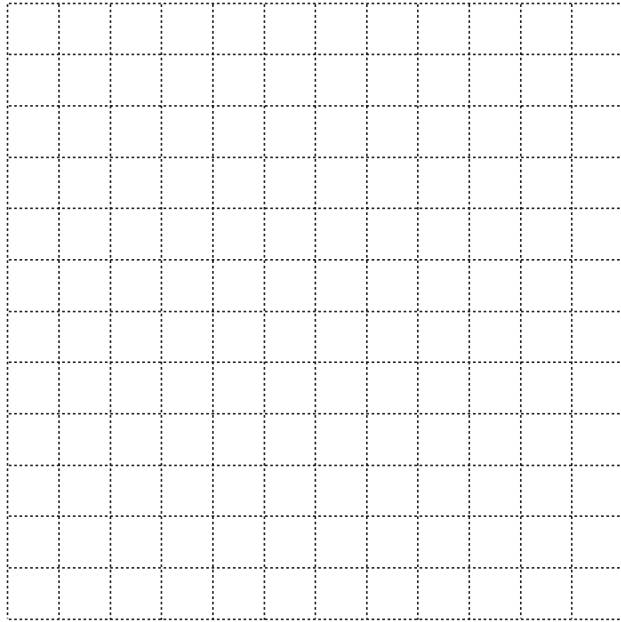
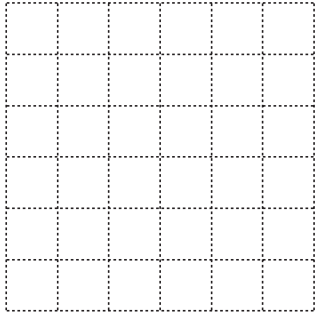

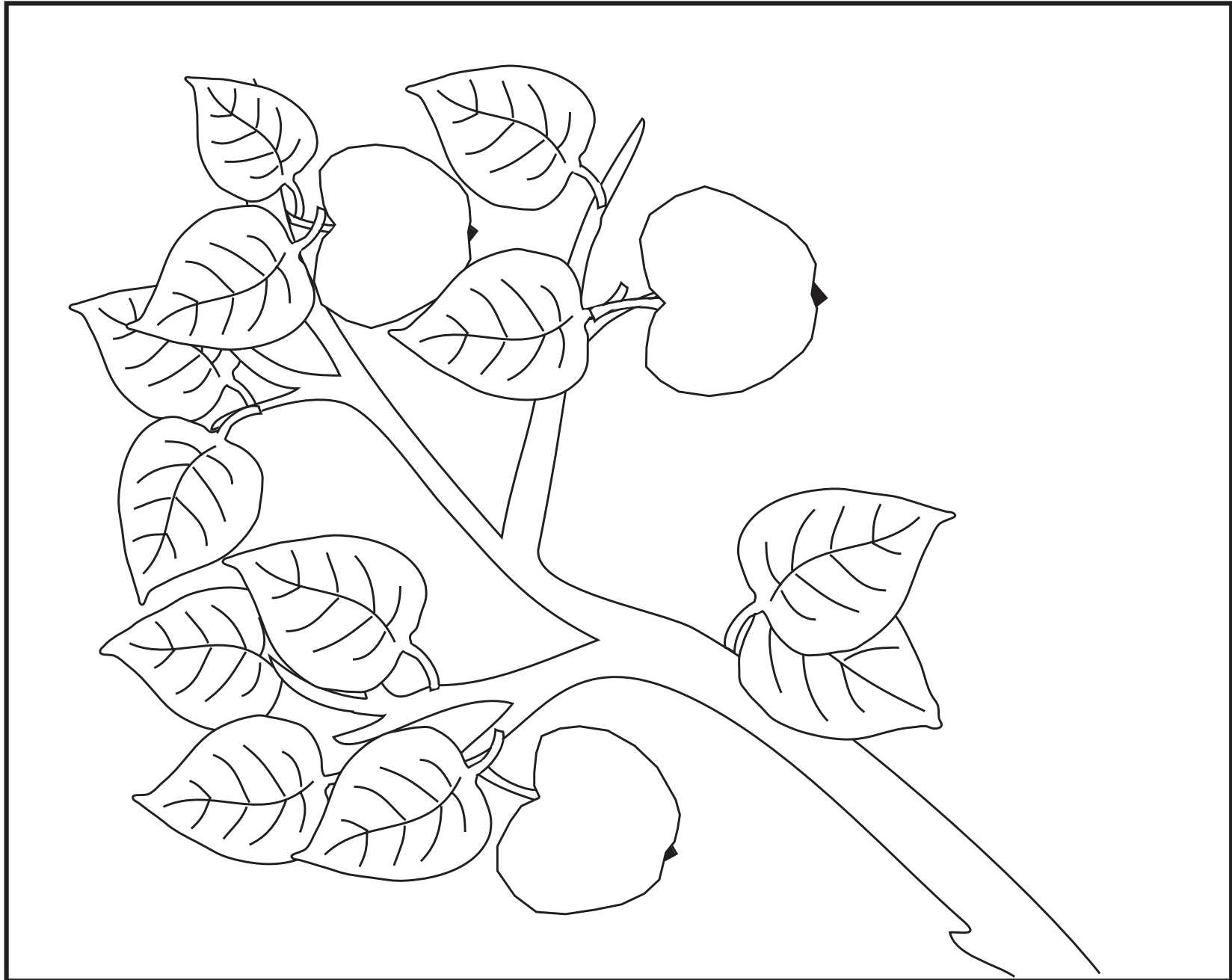

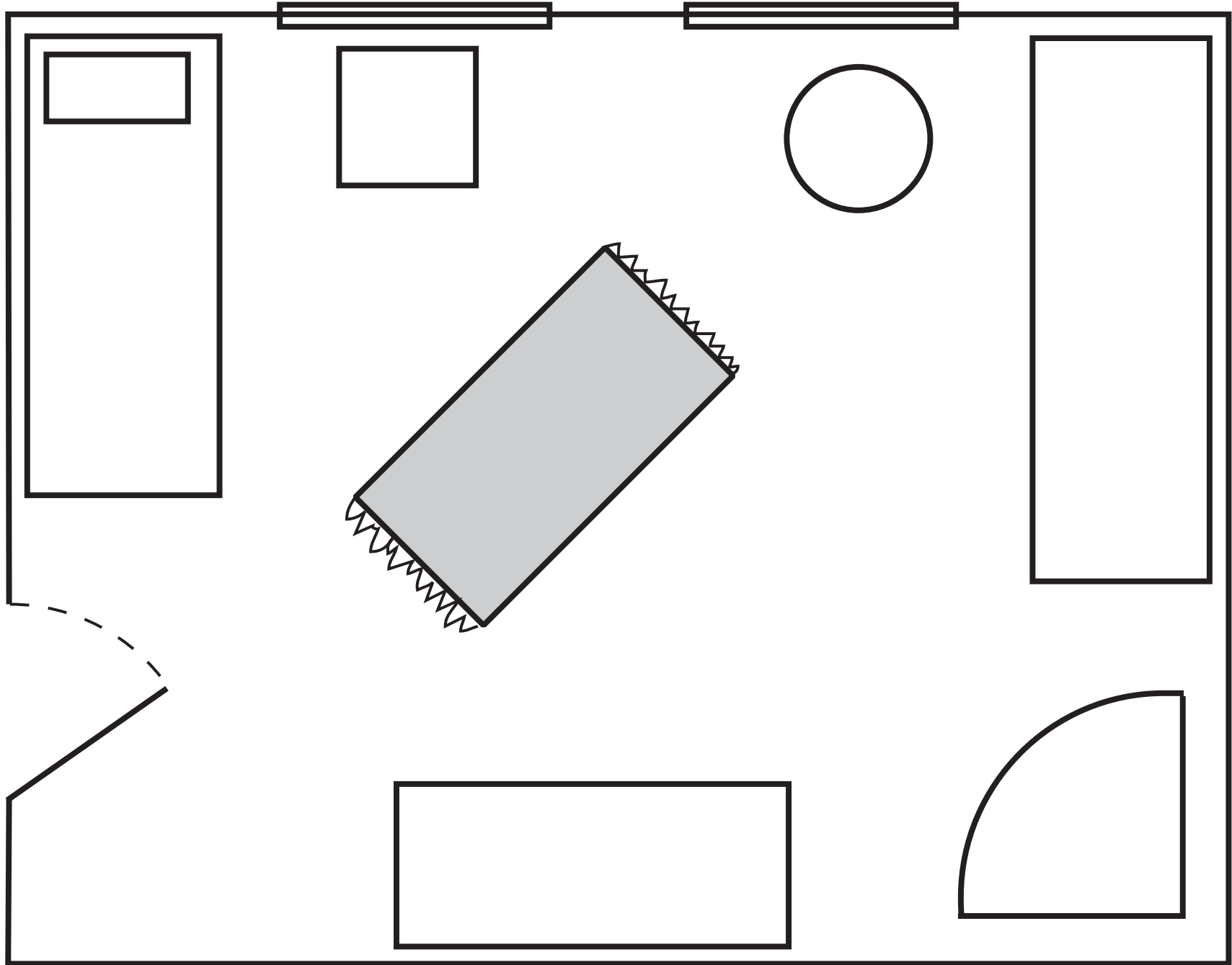

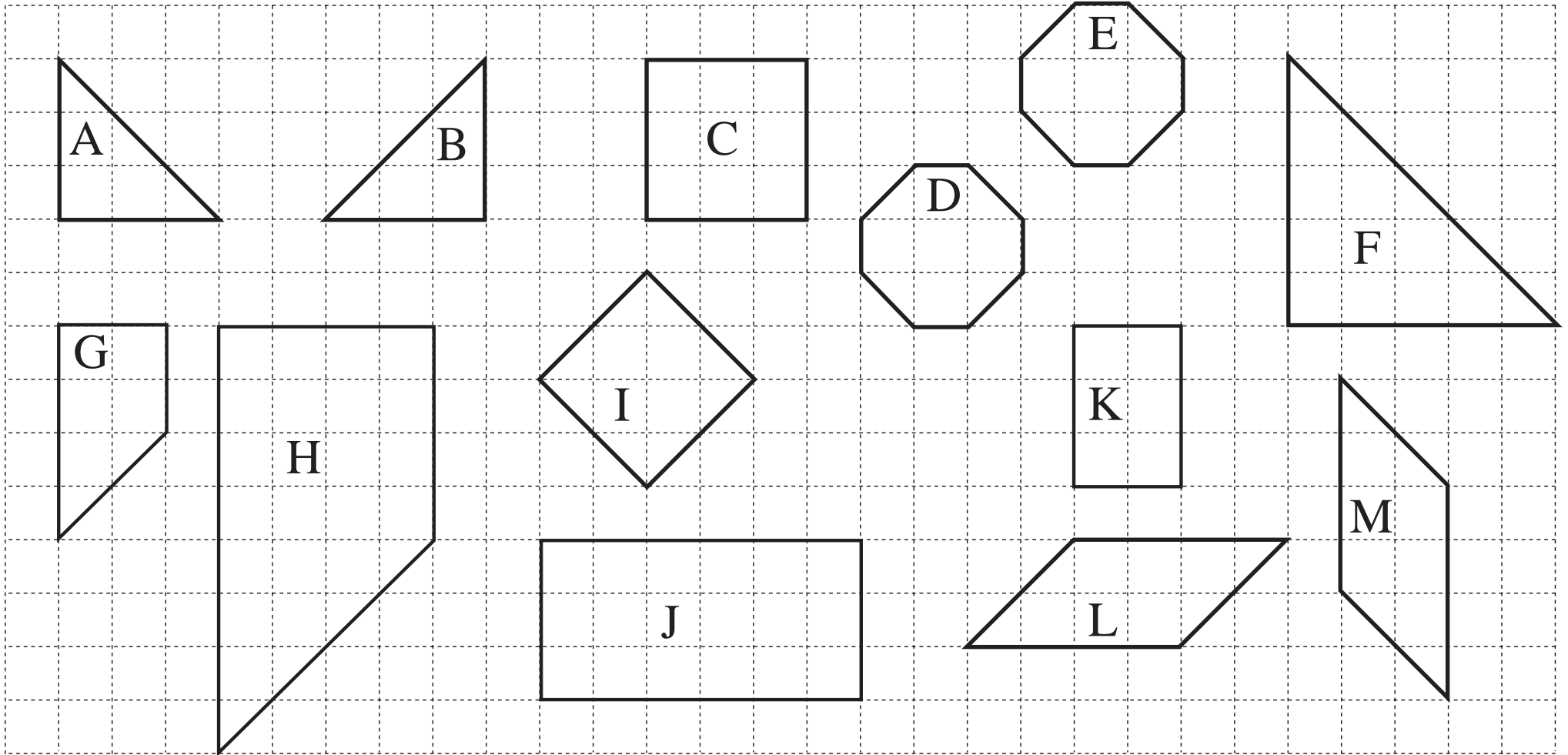

a) i)

	3	4	2
+			
<hr/>			
	5	8	9

ii)

	5	4	6
+			
<hr/>			
1	3	7	6

iii)

4	0	3
+		
<hr/>		
9	4	3

iv)

	9	9	9
+			
<hr/>			
1	8	8	8

v)

	3		2
+		4	6
<hr/>			
	2	5	

vi)

1		8	
+		0	3
<hr/>			
2	4		

b) i)

9	5	6
-		
<hr/>		
6	1	4

ii)

7	4	3
-		
<hr/>		
1	5	2

iii)

-	5	2	6
<hr/>			
3	1	2	

iv)

-	4	7	9
<hr/>			
2	1	8	

v)

8	5		
-		3	4
<hr/>			
6		2	

vi)

7		1	
-	5	9	
<hr/>			
	5	2	

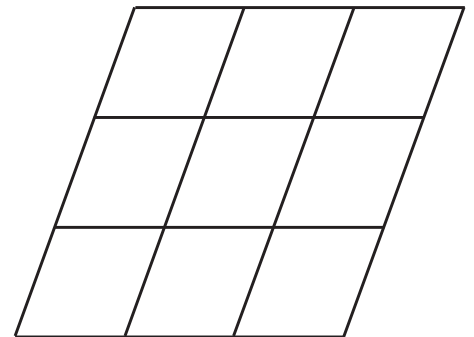
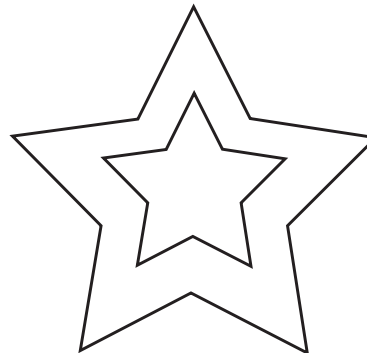
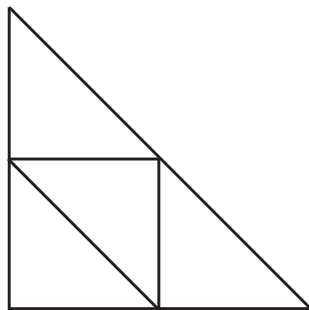
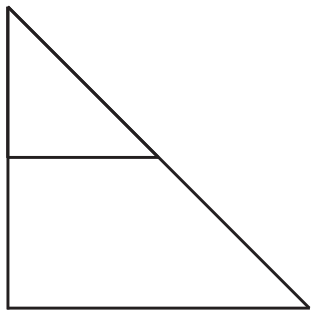
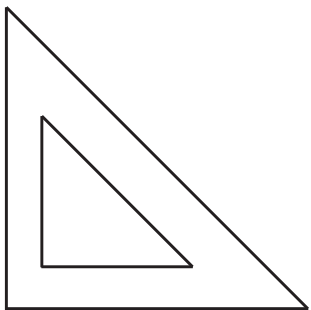
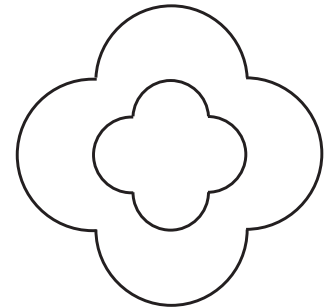
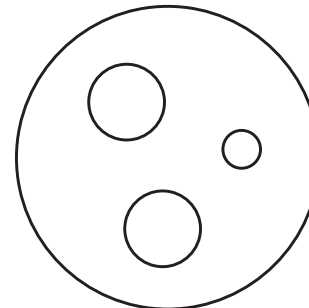
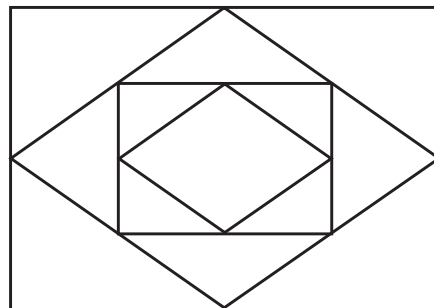
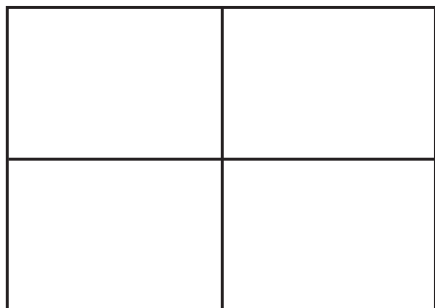
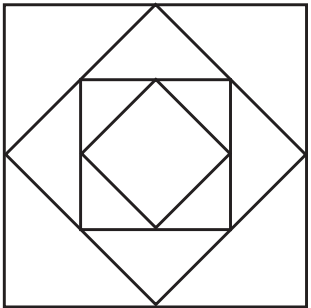
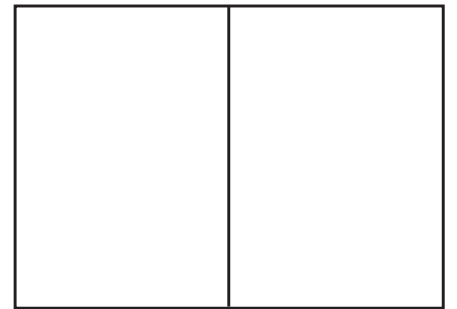
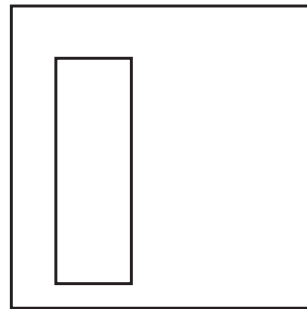
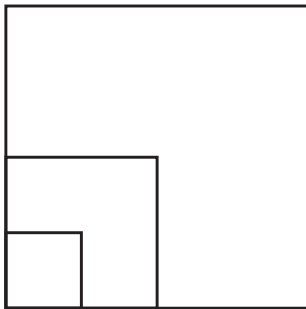
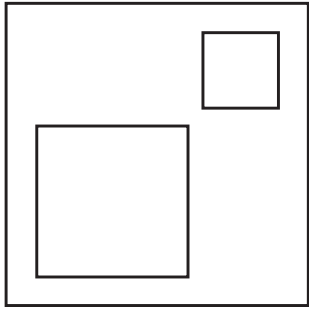
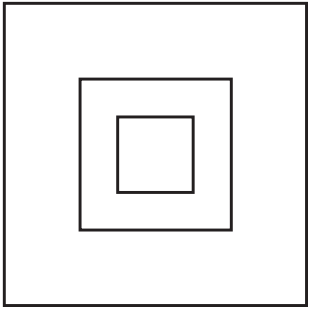

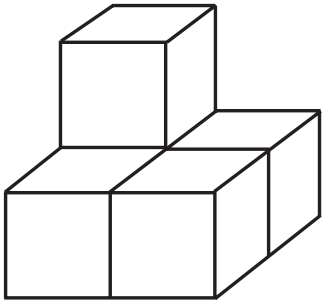

2	1
1	1

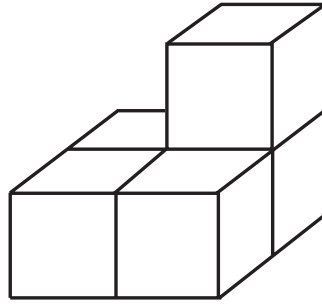

1	2
1	1

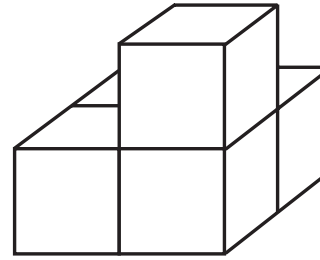

1	1
1	2

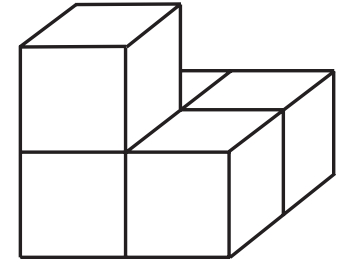

1	1
2	1

LP 118/6

<i>Solids</i>	a)	b)	c)	d)	e)
<i>Volume</i> (unit cubes)					
<i>Area</i> (unit squares)					

LP 118/7b

a)

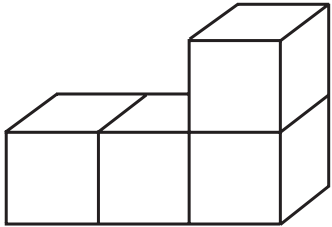

unit cubes

b)

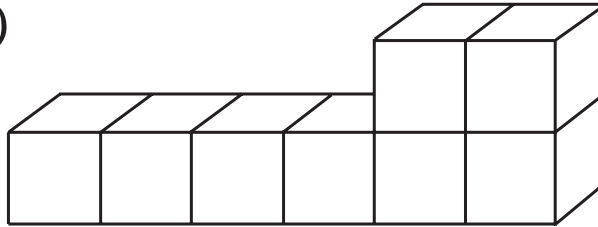

unit cubes

c)

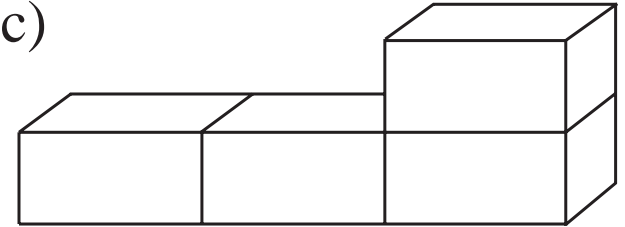

2-unit cuboids

d)

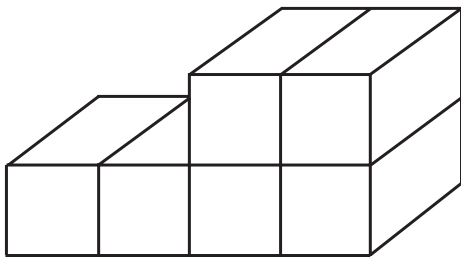

2-unit cuboids

e)

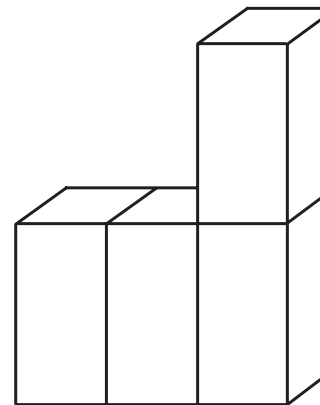

2-unit cuboids

a) i)

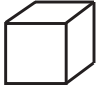

ii)

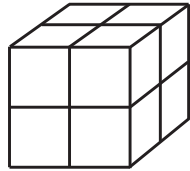

iii)

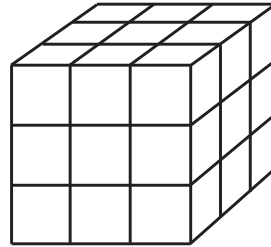

iv)

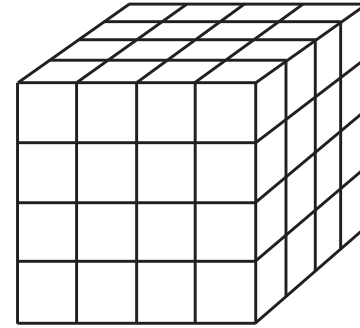

b) i)

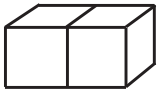

ii)

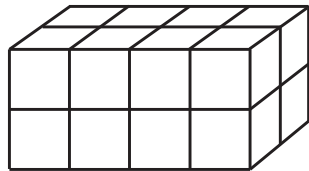

iii)

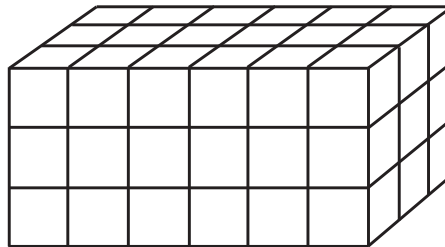

iv)

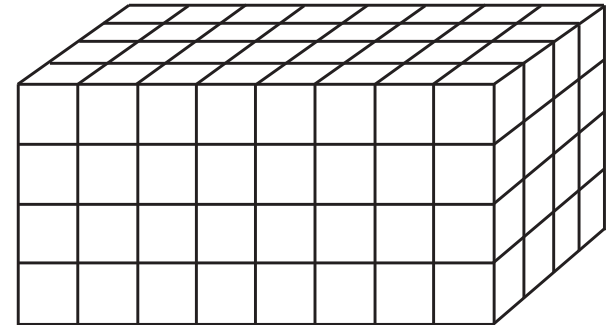

c) i)

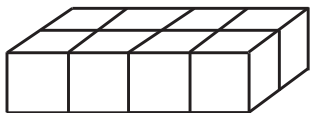

ii)

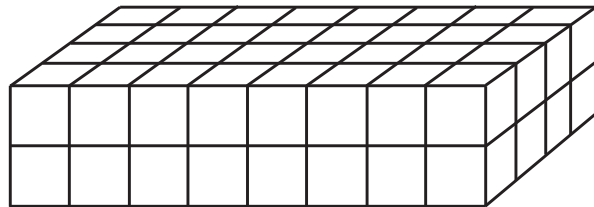

iii)

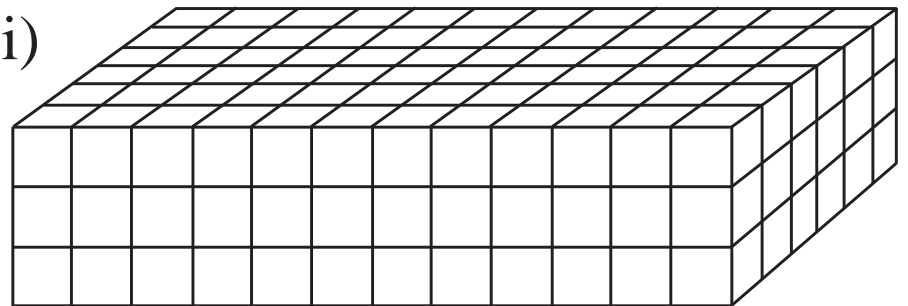

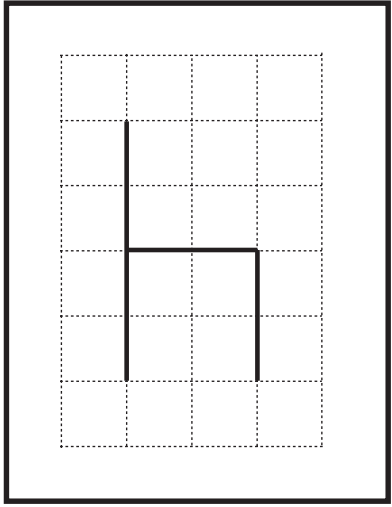

a)

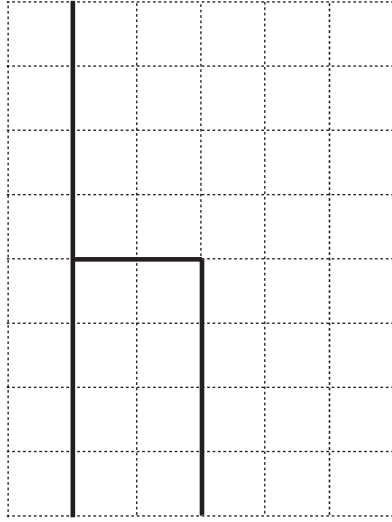

b)

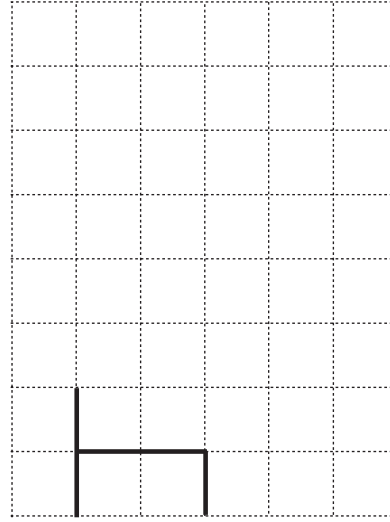

c)

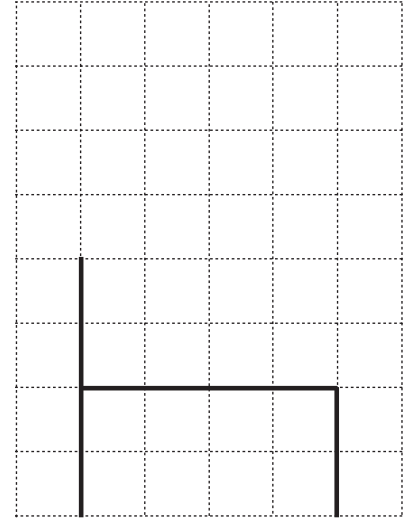

d)

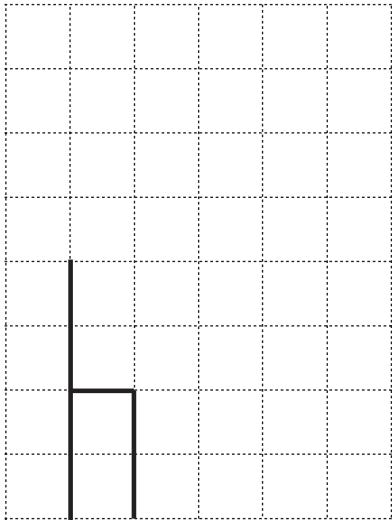

e)

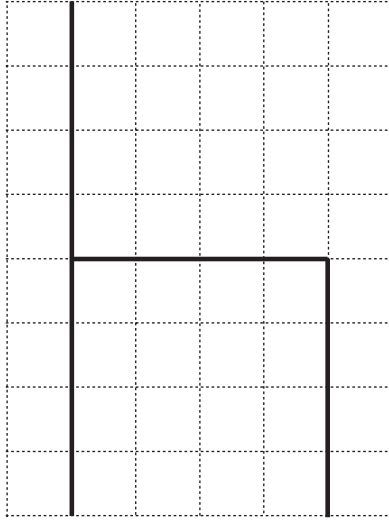

f)

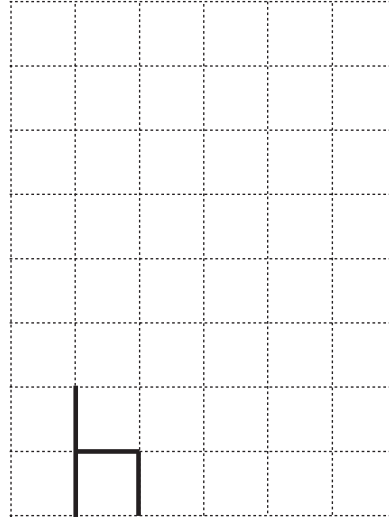

g)

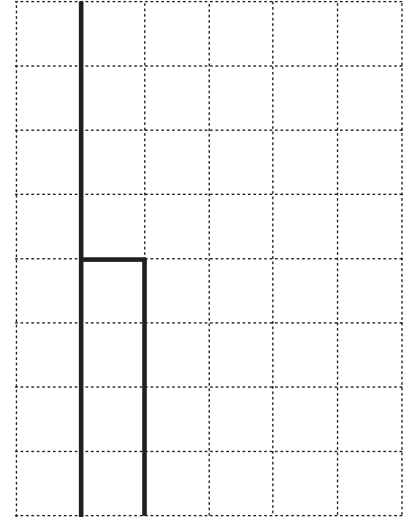

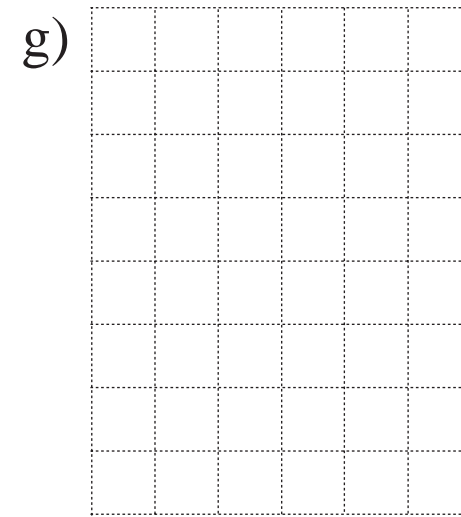
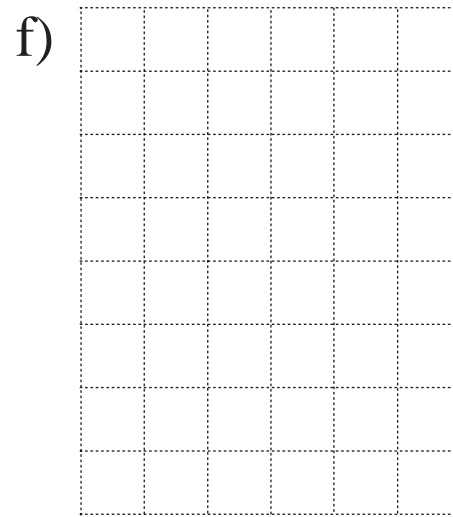
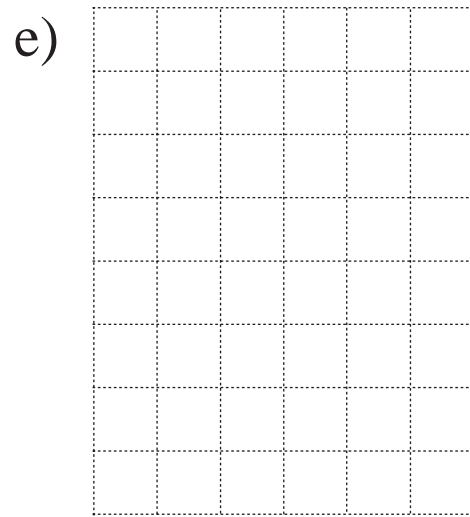
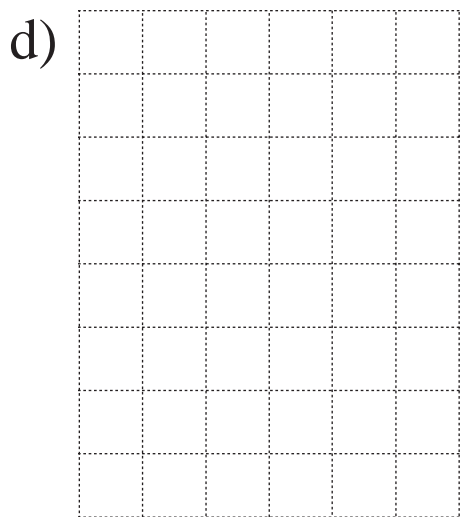
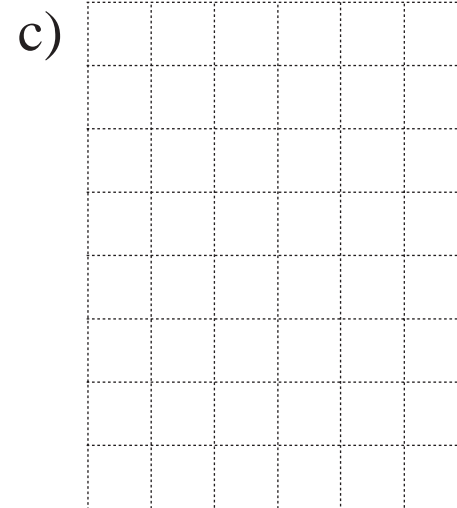
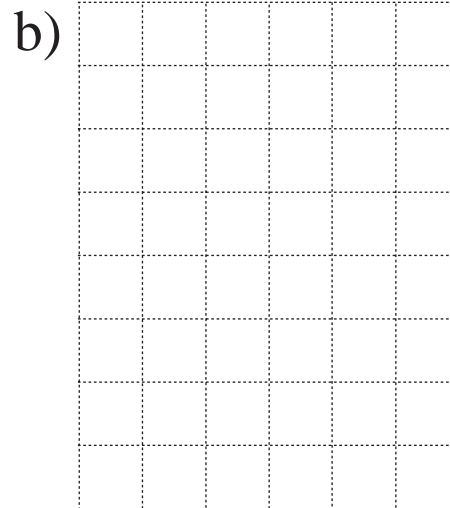
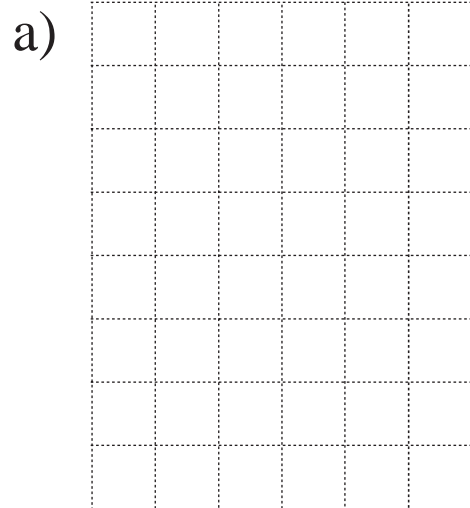
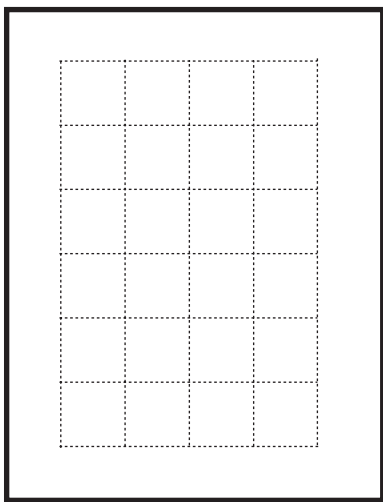

a) Top view Ground plan Front view Side view

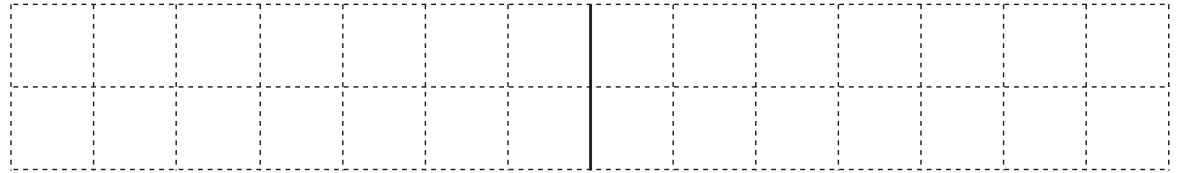
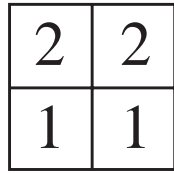
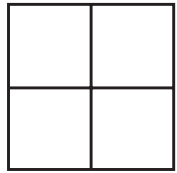

b) Top view Ground plan Front view Side view

i)

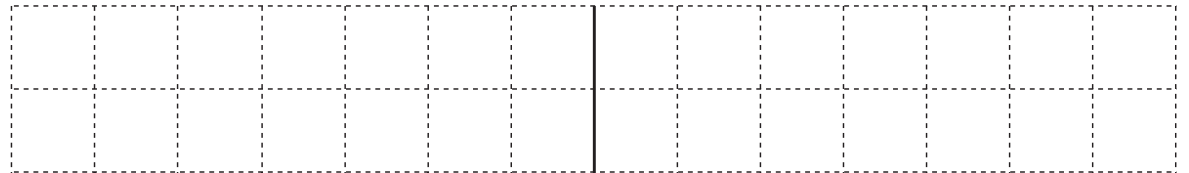
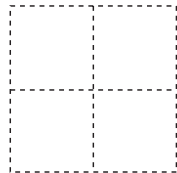
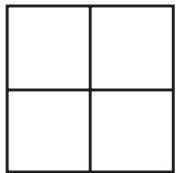

ii)

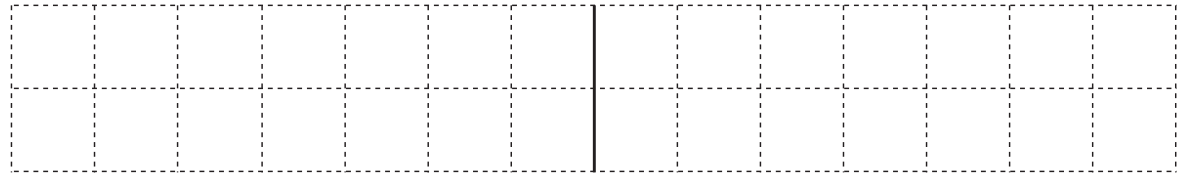
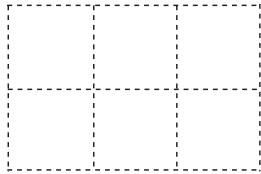
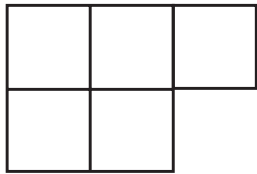

iii)

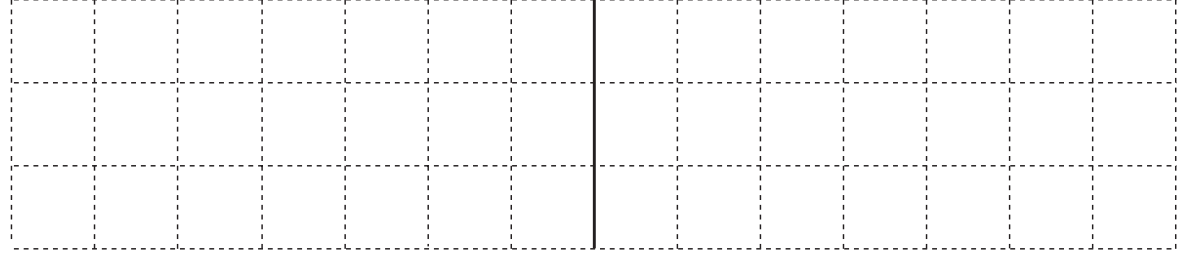
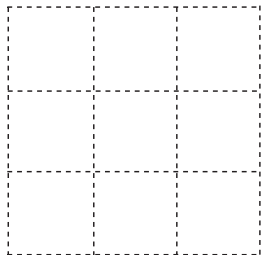
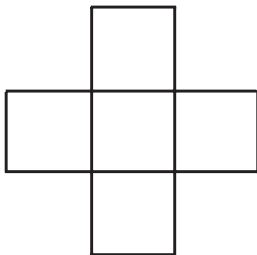

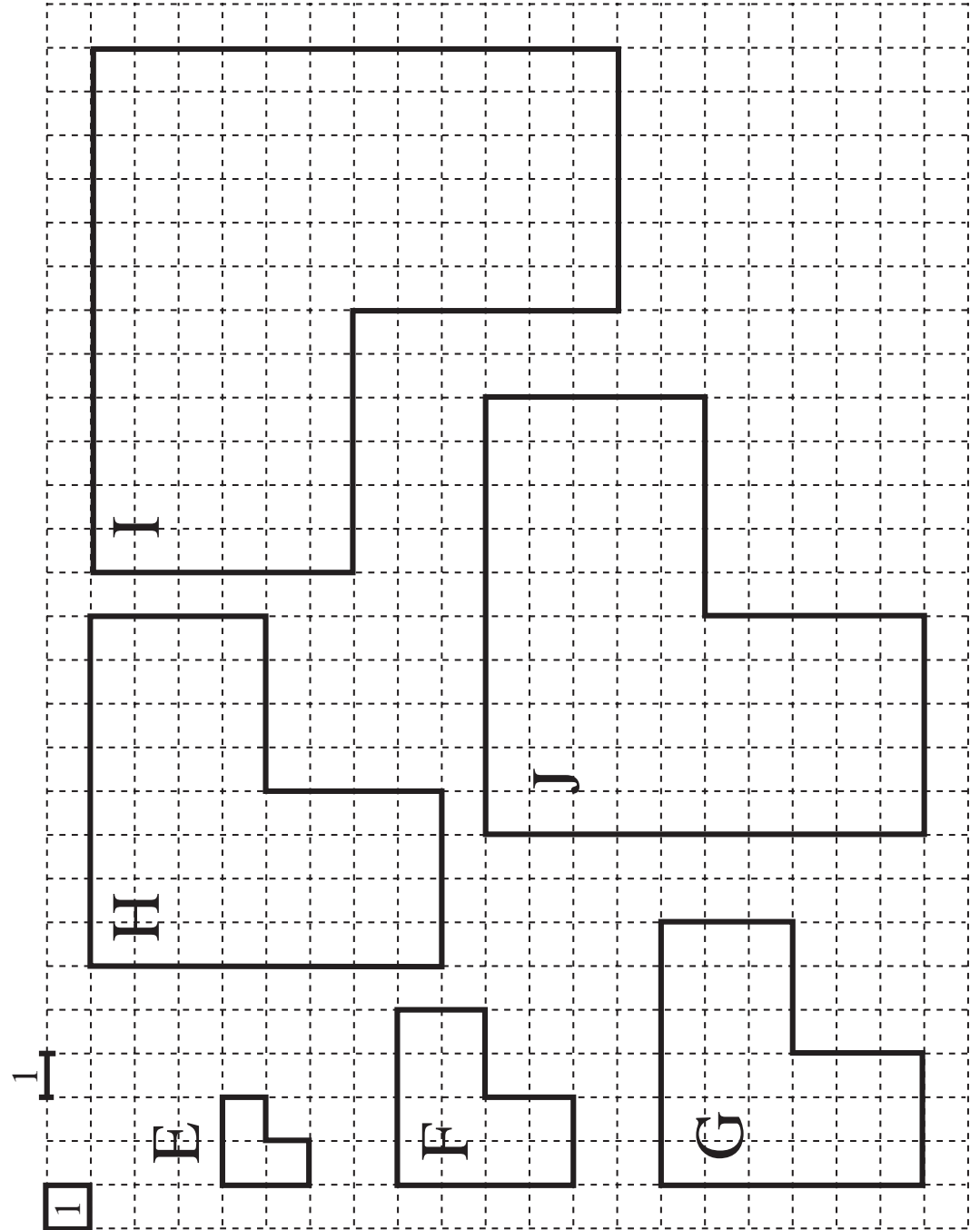
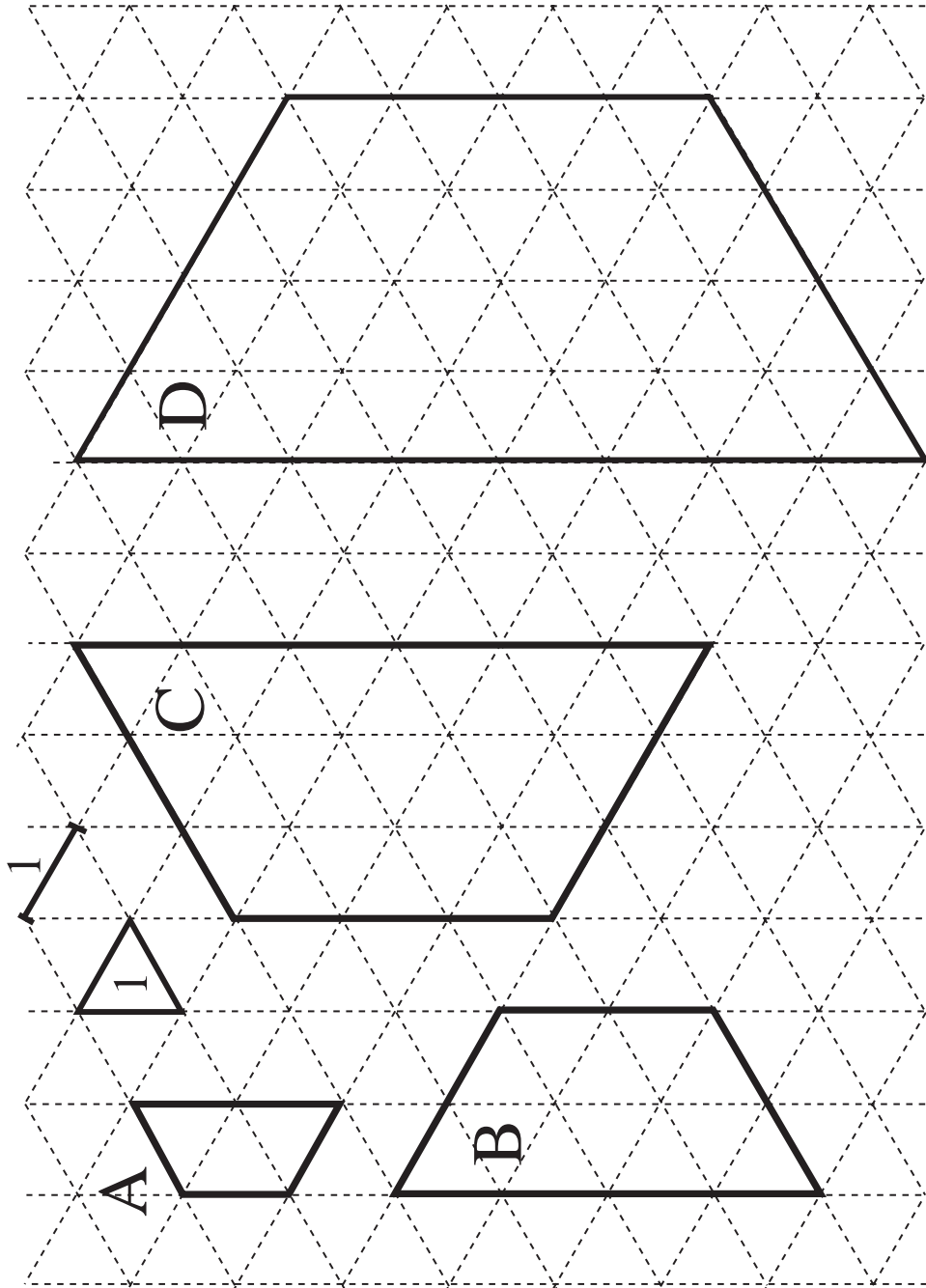

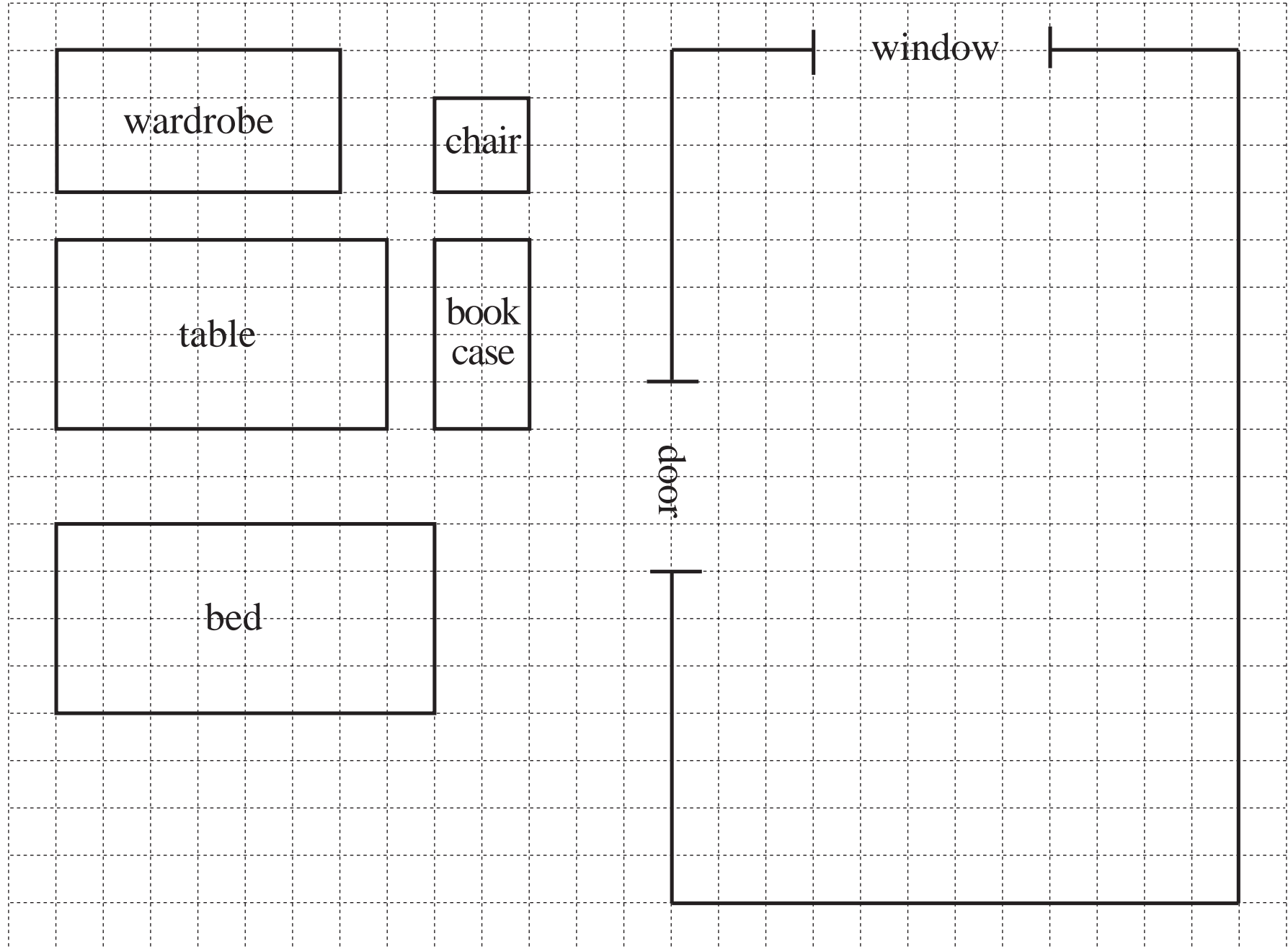

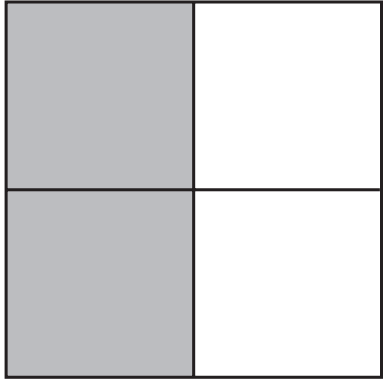

2 halves

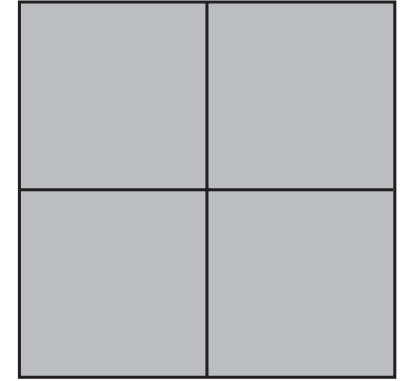

1 half

2 thirds

4 eighths

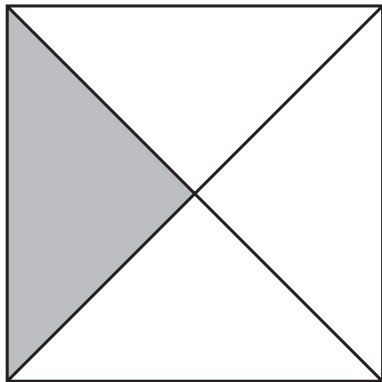

1 quarter

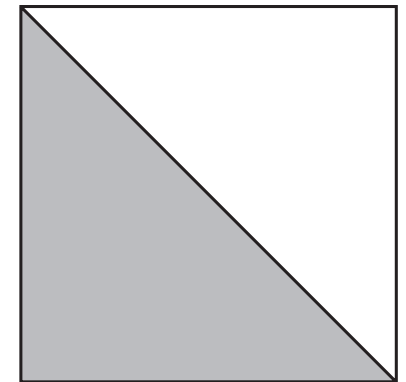
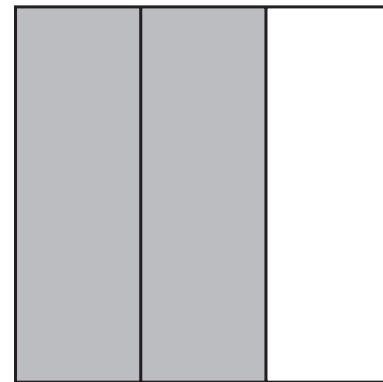
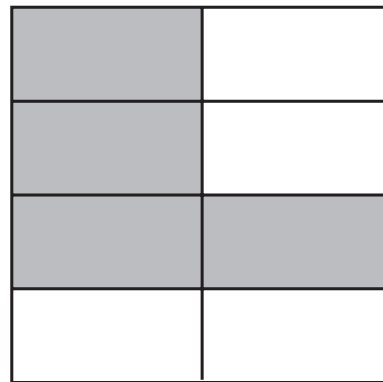

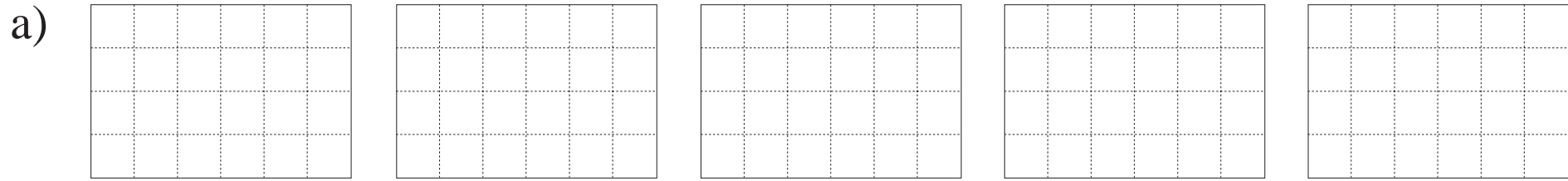

1 half

1 quarter

1 third

1 sixth

1 twelfth

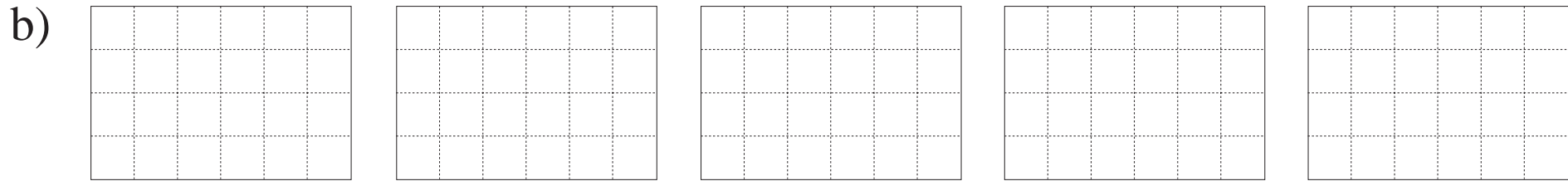

2 halves

2 quarters

2 thirds

2 sixths

2 twelfths

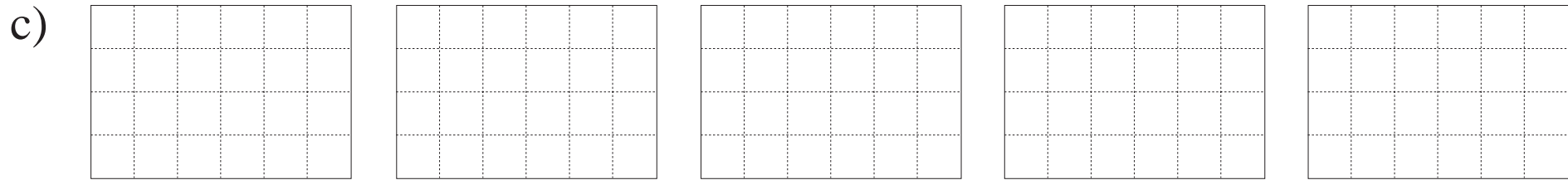

3 eighths

3 quarters

3 thirds

3 sixths

3 twelfths

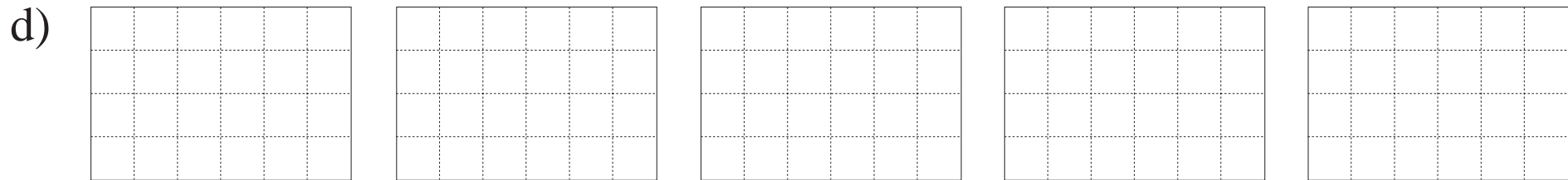

4 eighths

4 quarters

4 twelfths

6 sixths

6 twelfths

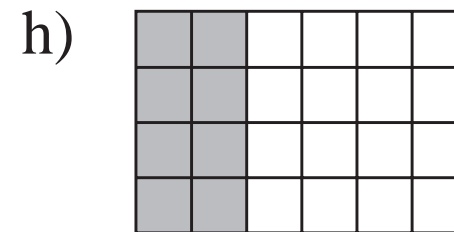
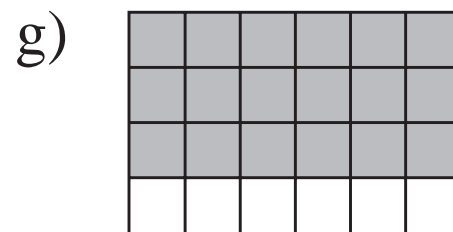
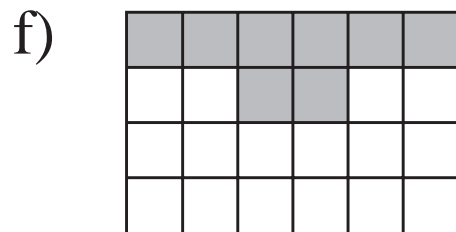
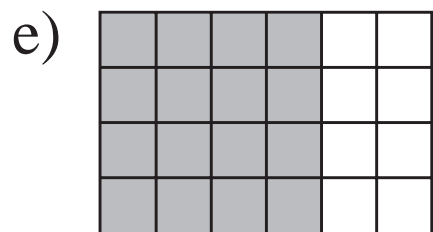
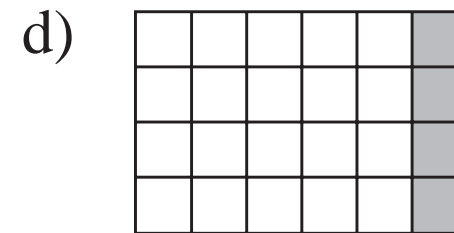
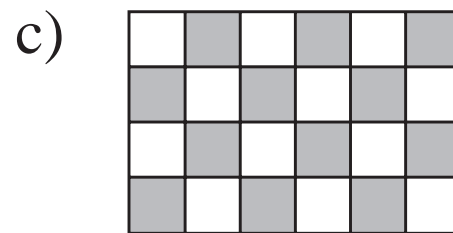
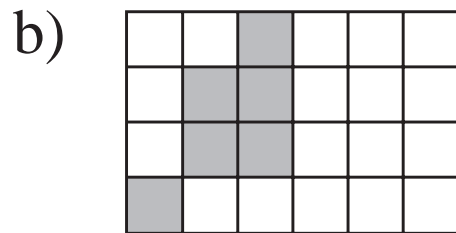
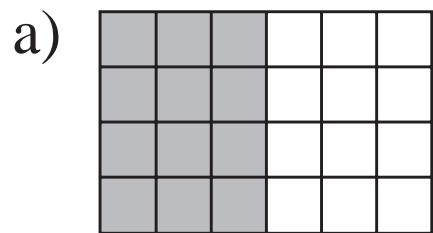

LP 121/5

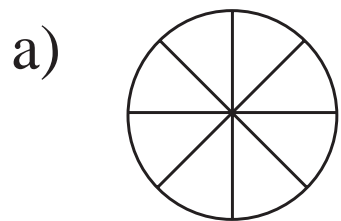

4 eighths

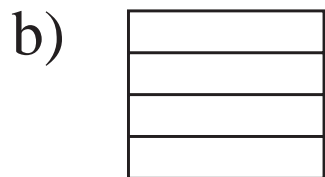

3 quarters

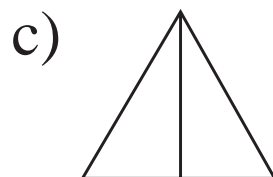

1 half

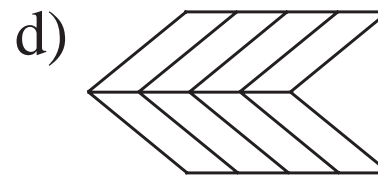

3 eighths



1 third

1 unit

a)

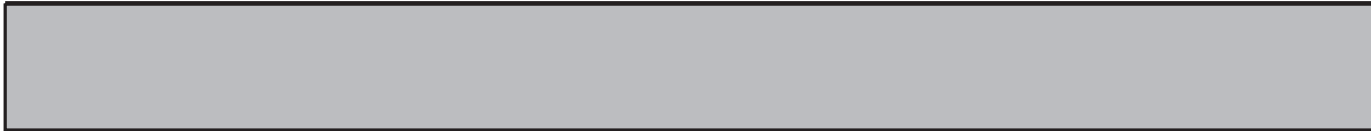

b)



c)

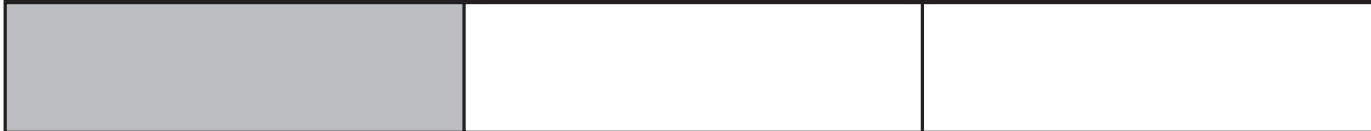

d)



e)



f)



g)

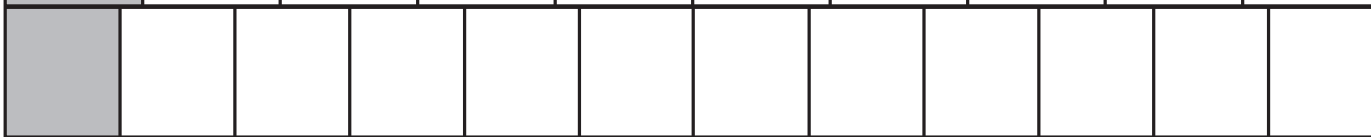

.....

.....

.....

.....

.....

.....

.....



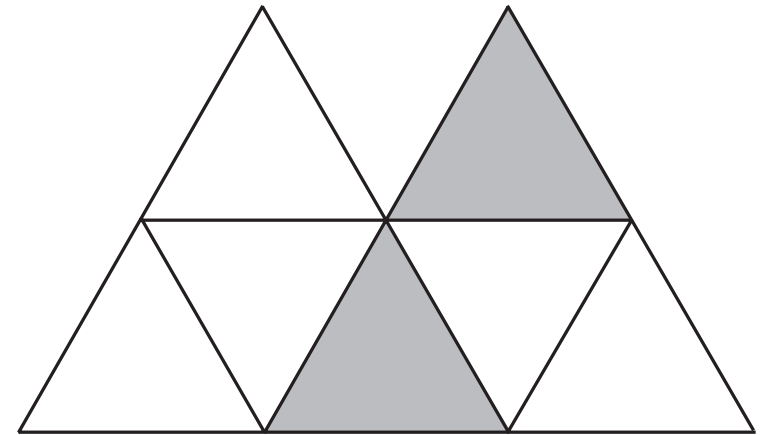
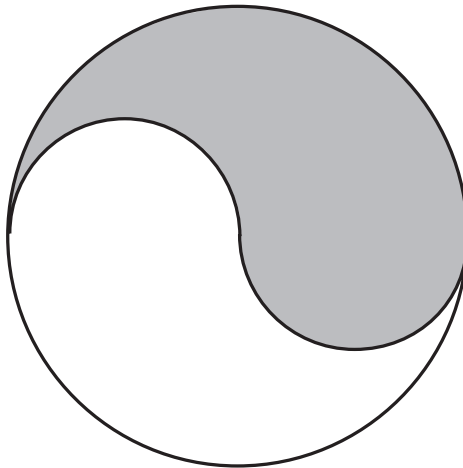
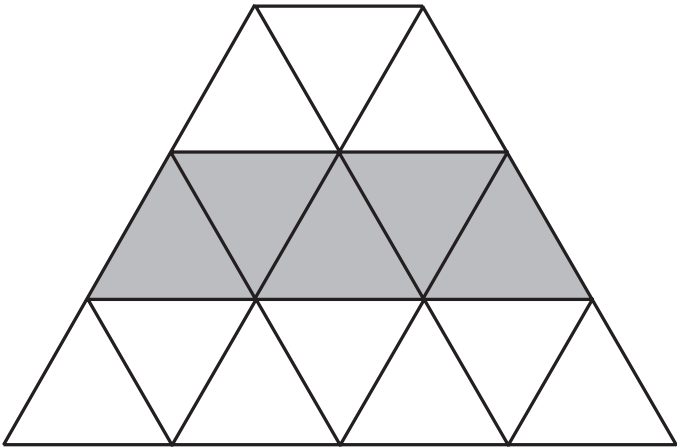
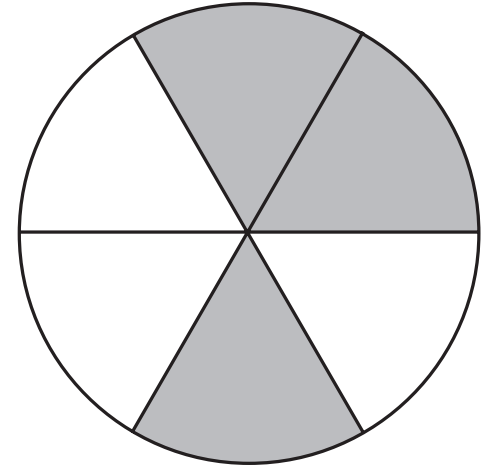
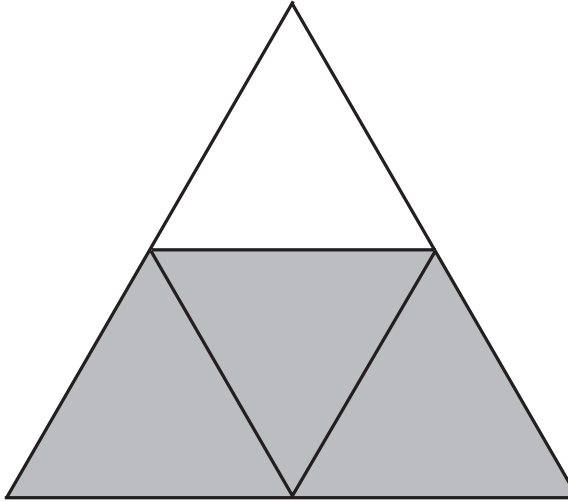
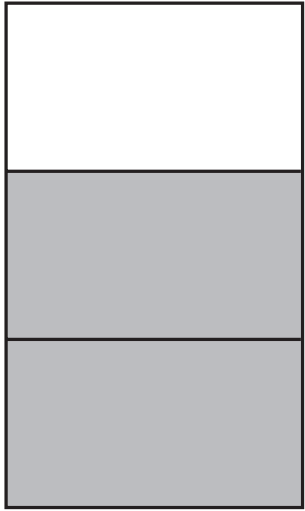

a)

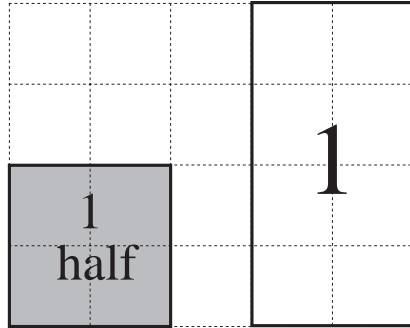

b)

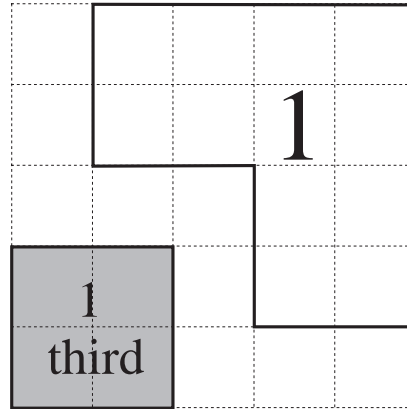

c)

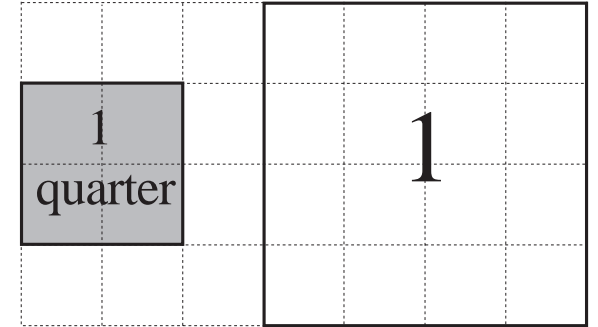

d)

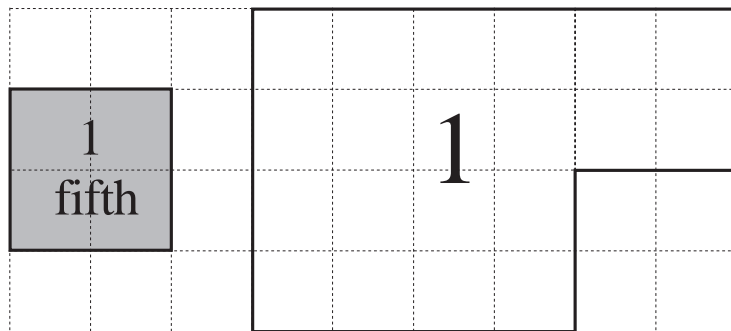

e)

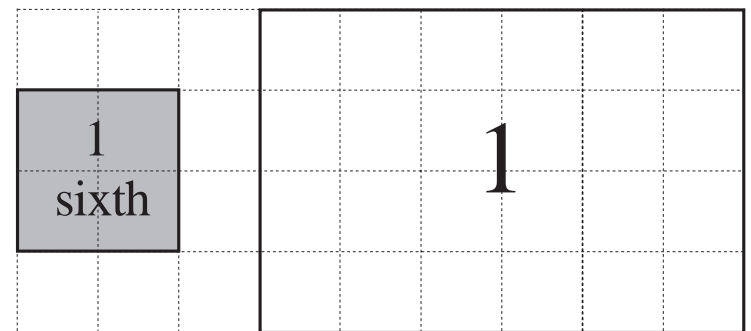

1 unit

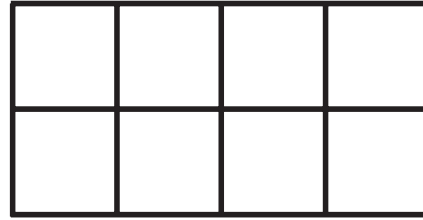

a)



b)



c)



d)

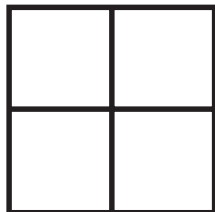

e)

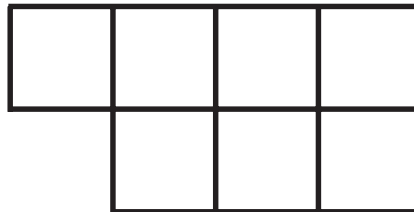

f)

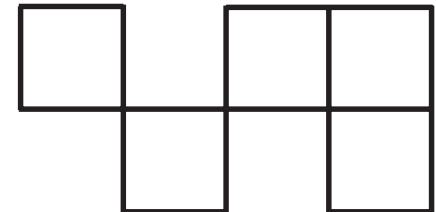

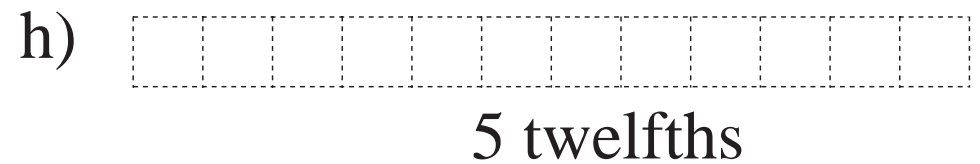
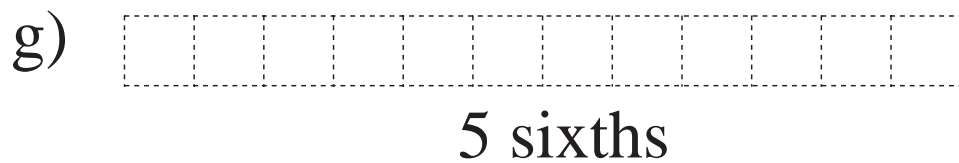
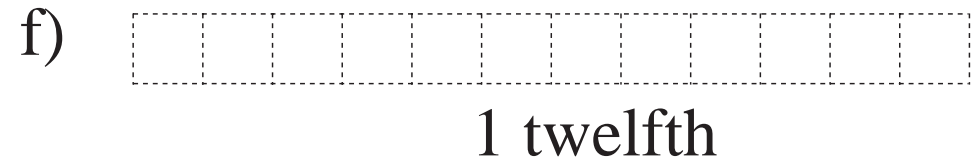
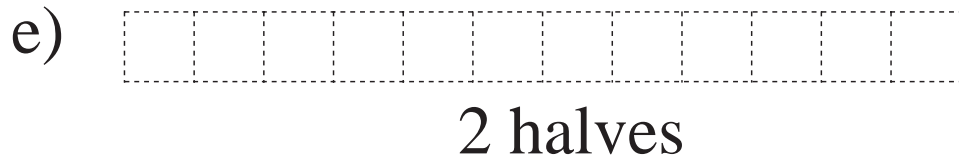
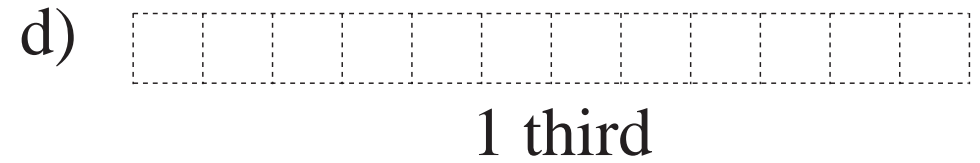
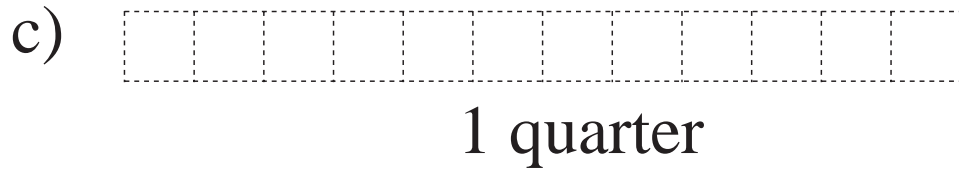
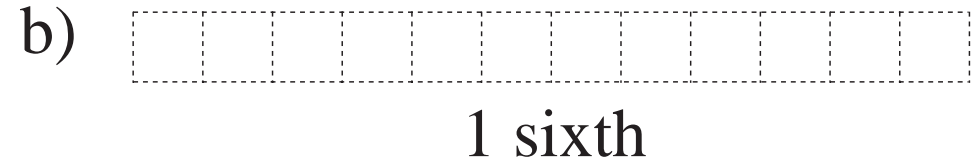
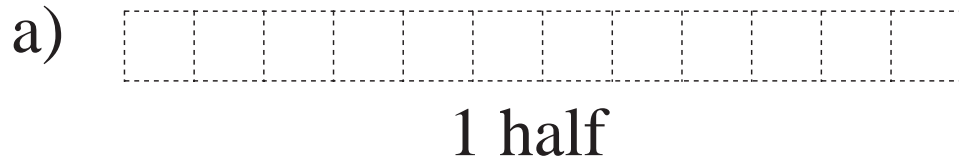

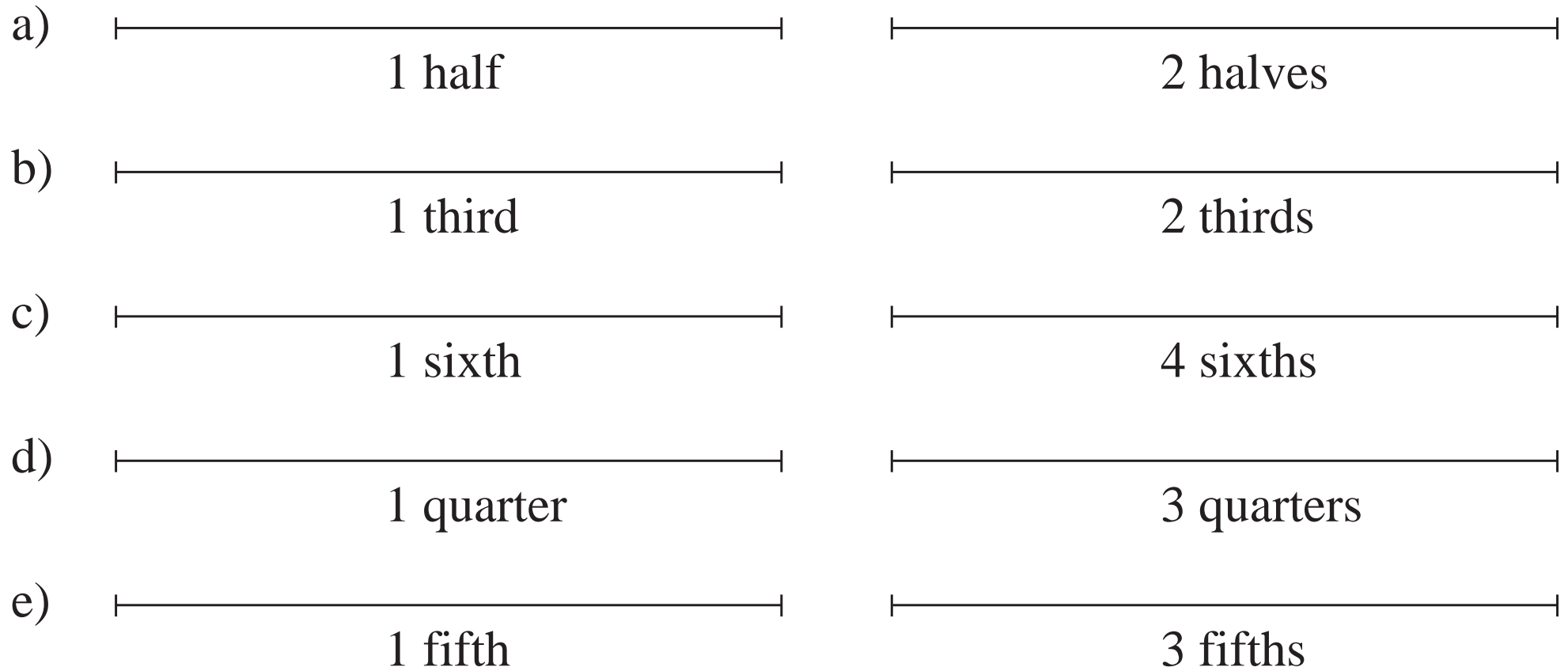

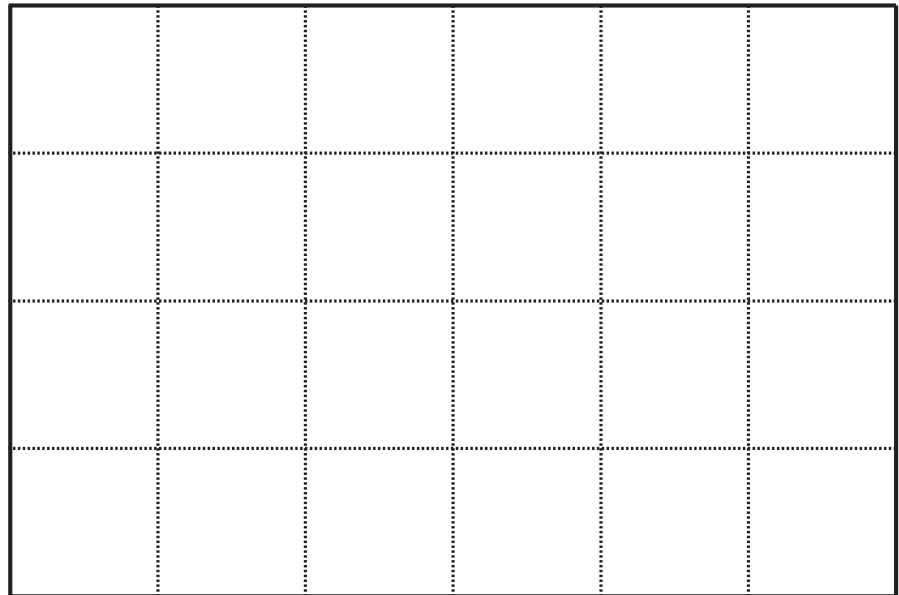
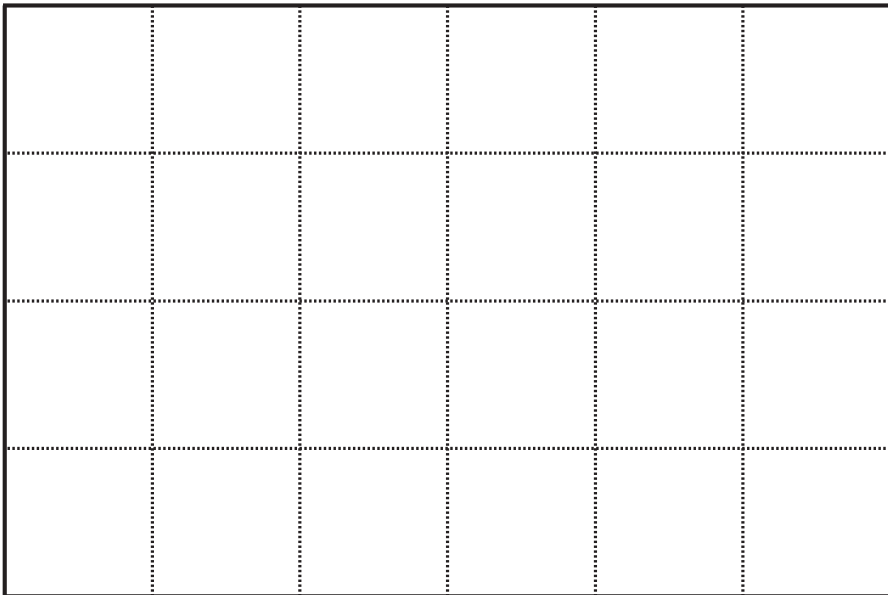
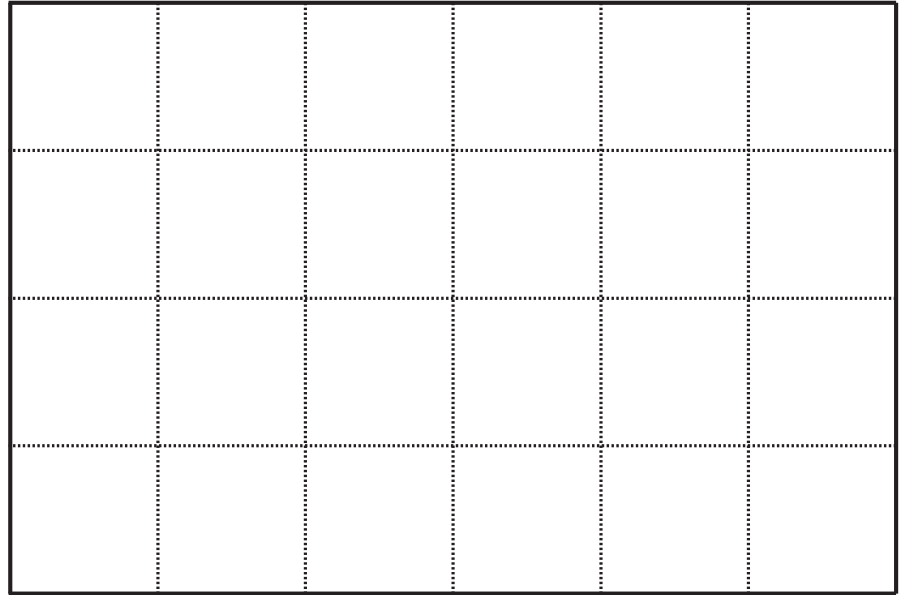
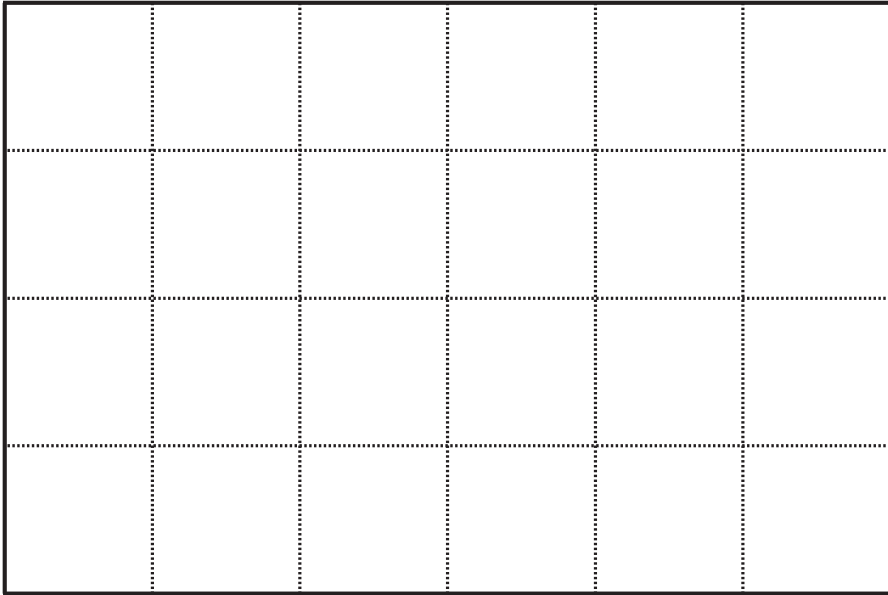

a)

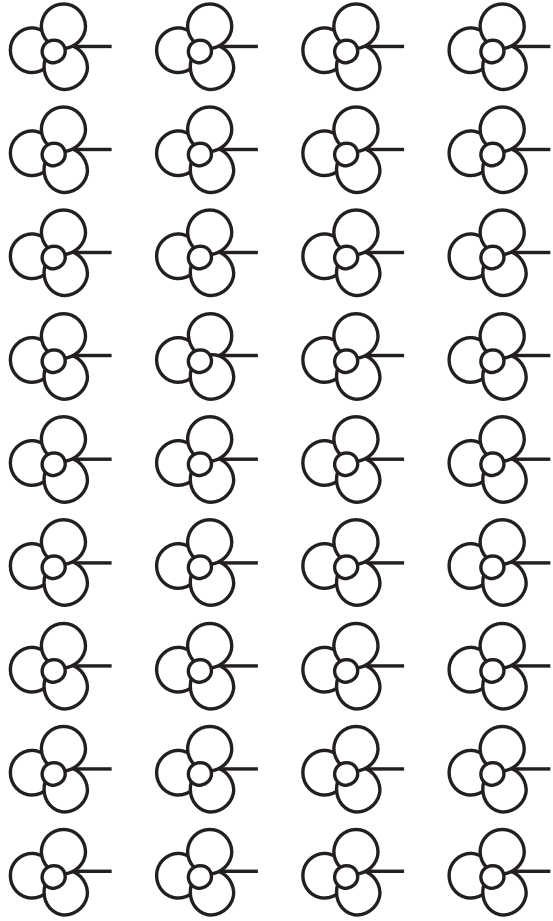

b)

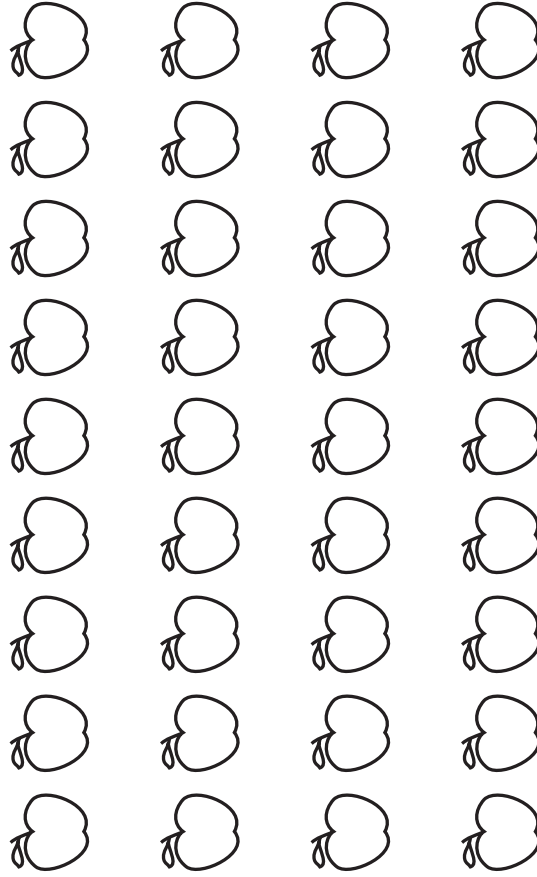

c)

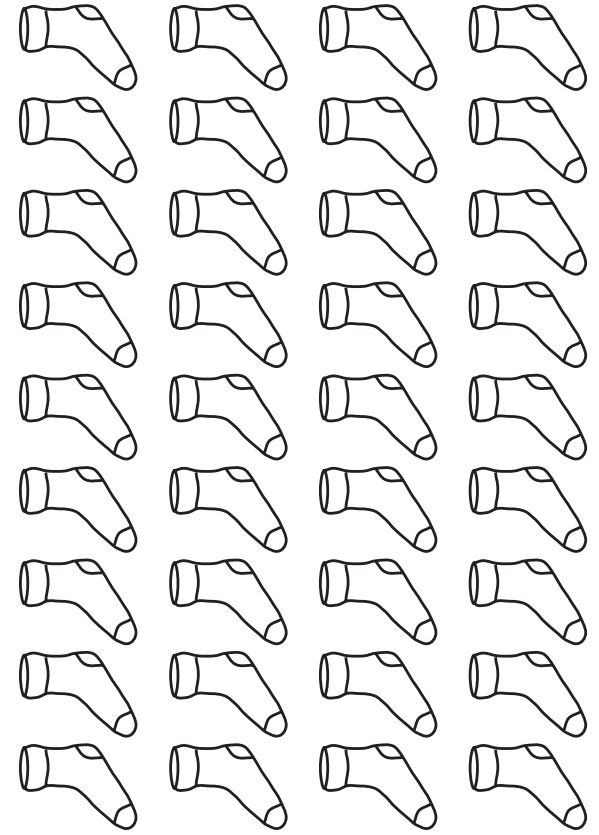

a)

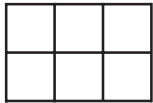
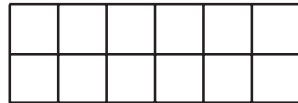
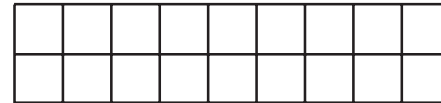
 half

 halves

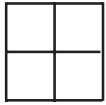
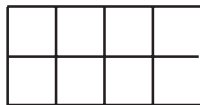
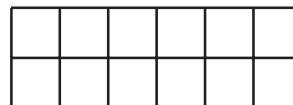
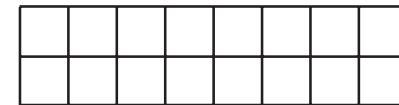
 halves

b)

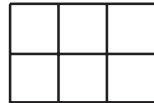
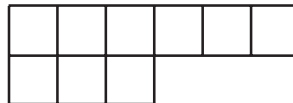
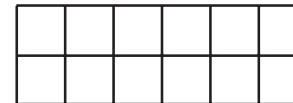
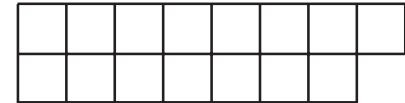

 third

 thirds

 thirds

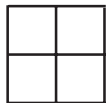
 thirds

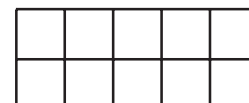
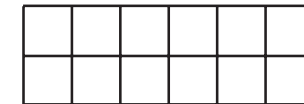
c)



 quarter

 quarters

 quarters

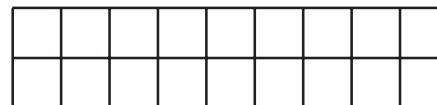
 quarters

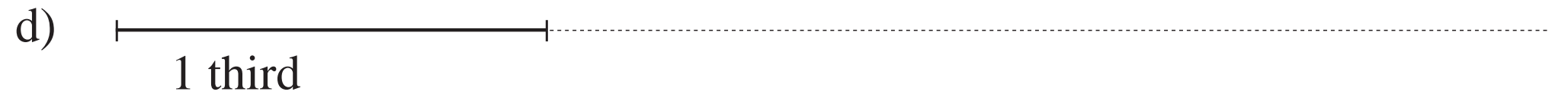
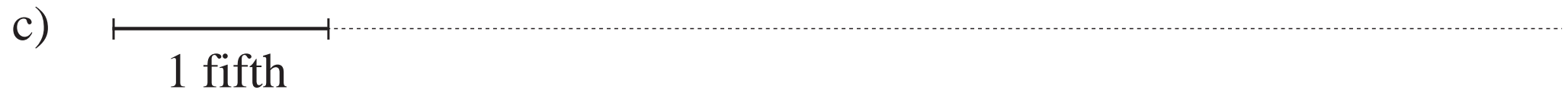
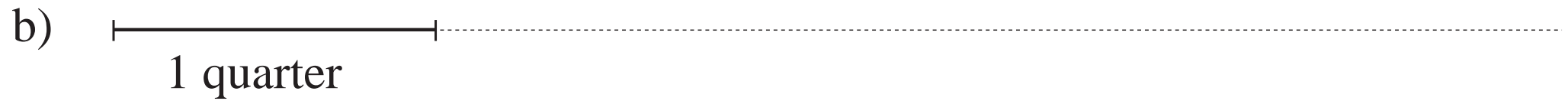
 quarters

d)



 sixth

 sixths

 sixths

 sixths

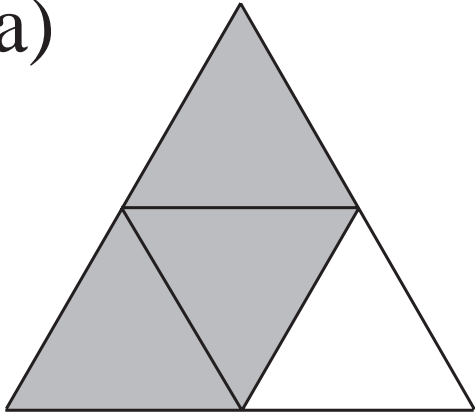
 sixths

 sixths

 sixths



a)



1 half

b)

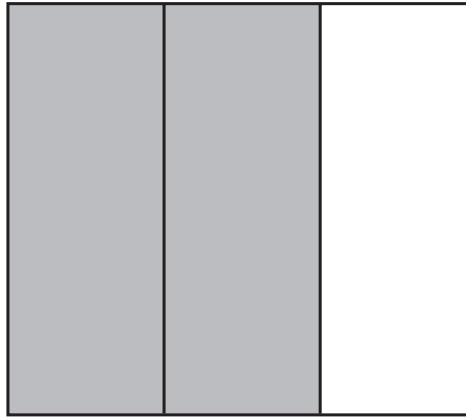

2 thirds

c)

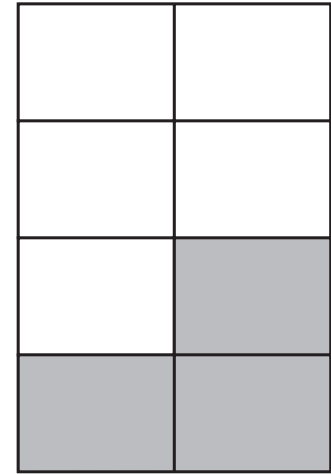

3 eighths

d)

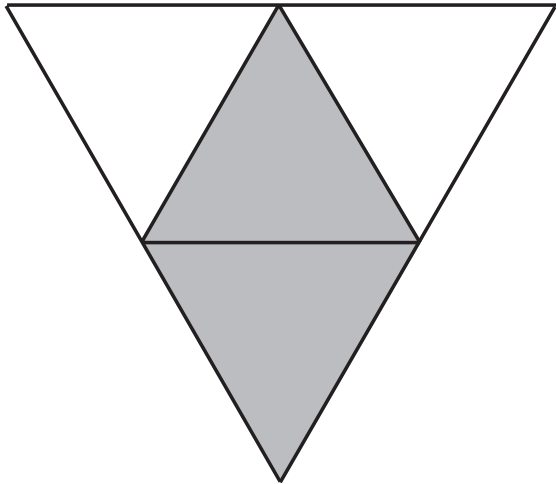

2 quarters

e)

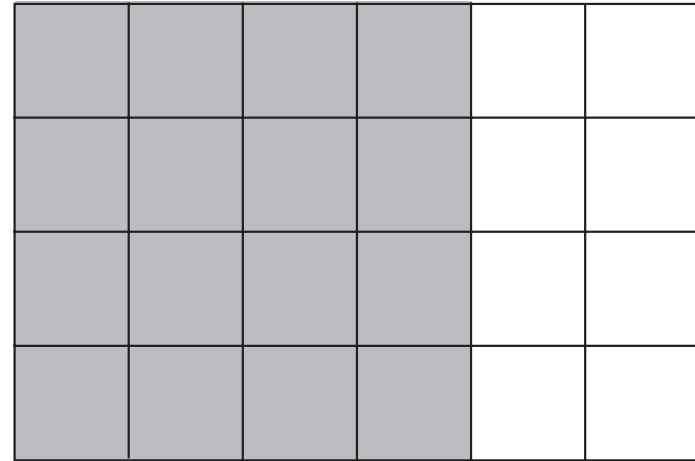

3 quarters

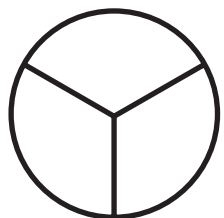

1

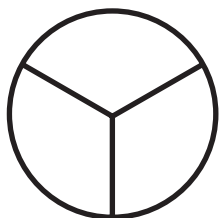

2

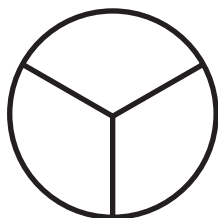

3

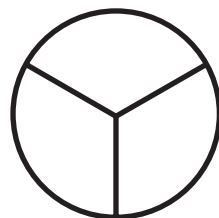

4

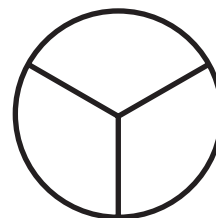

5

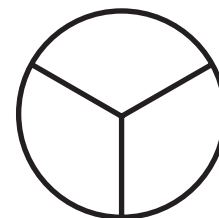

6

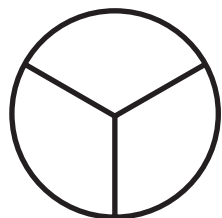

7

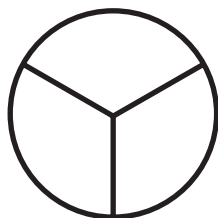

8

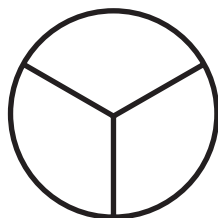

9

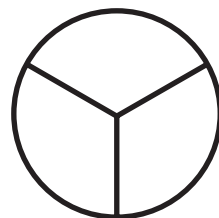

10

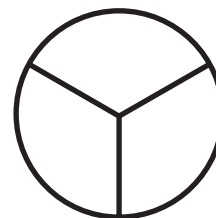

11

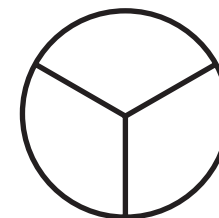

12

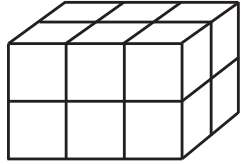
1 unit = 

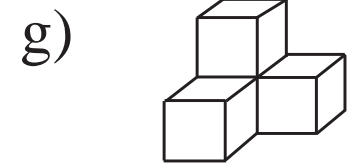
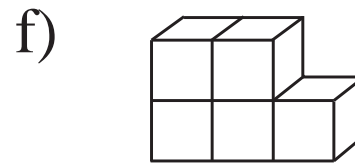
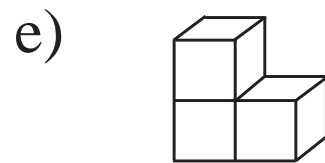
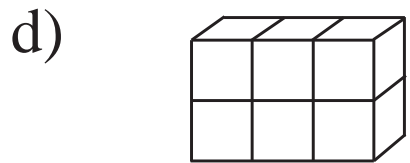
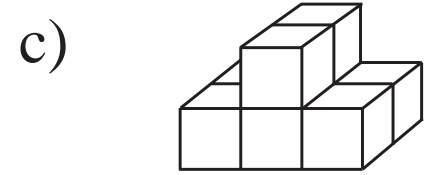
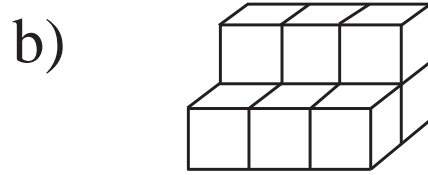
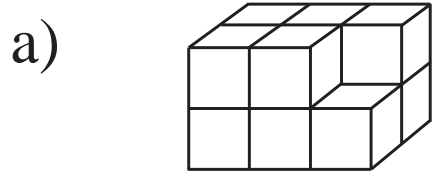

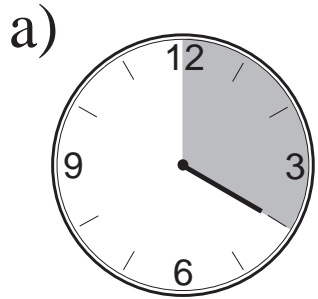

20 minutes

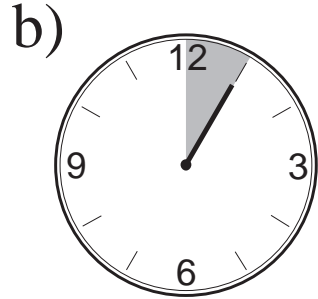
 hour

5 minutes

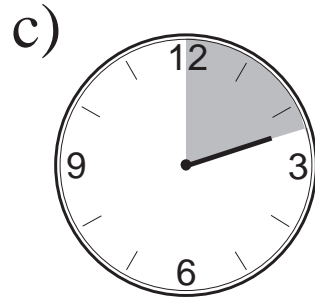
 hour

12 minutes

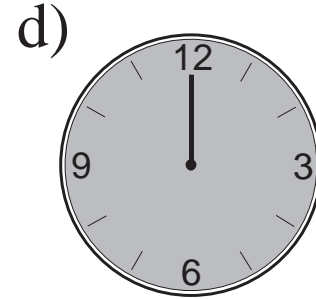
 hour

60 minutes

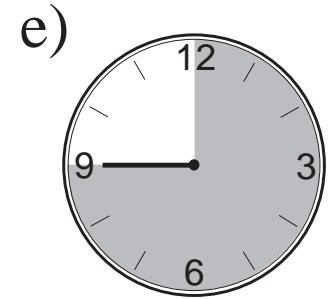
 hour

45 minutes

 hour

LP 124/7

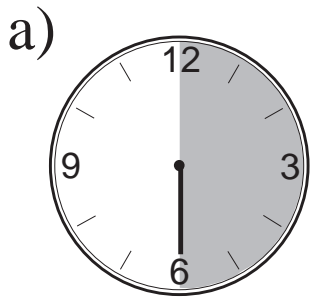

half an hour

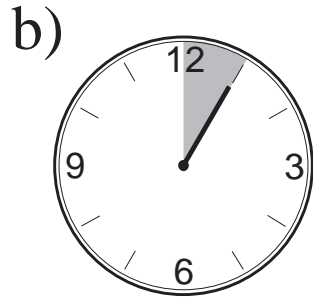
 min.

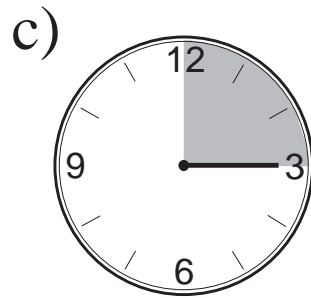
 1 twelfth
of an hour

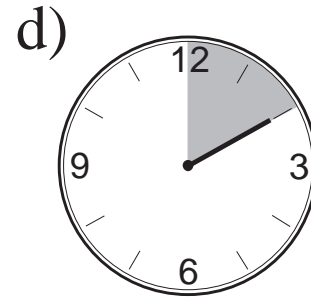
 min.

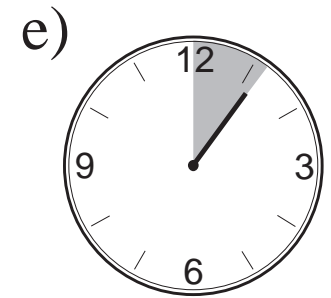
 1 quarter
of an hour

 min.

 1 sixth
of an hour

 min.

 1 tenth
of an hour

 min.

a) half a metre = cm

1 fifth of a metre = cm

1 tenth of a metre = cm

3 quarters of a metre = cm

3 fifths of a metre = cm

7 tenths of a metre = cm

11 hundredths of a metre = cm

b) half a kg = g

1 quarter of a kg = g

1 tenth of a kg = g

3 quarters of a kg = g

5 tenths of a kg = g

2 fifths of a kg = g

9 hundredths of a kg = g

a) $349 + 572 < 727 \square 199$

C:

	3	4	9
+	5	7	2

b) $942 - 443 > 849 \square 367$

C:

0, 4, 13, 30, 72, 95, 100, 321, 679, 1000, 1006, 1027, 2000

a)

Even	Odd

b)

Whole tens	Not whole tens

c)

3-digit	Not 3-digit

d)

Whole hundreds	Not whole hundreds

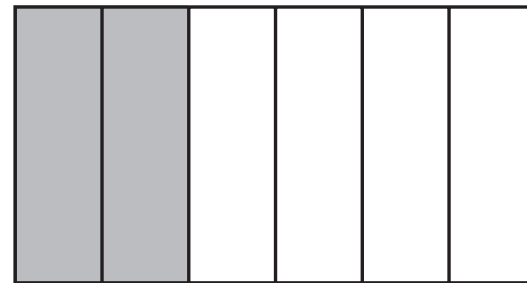
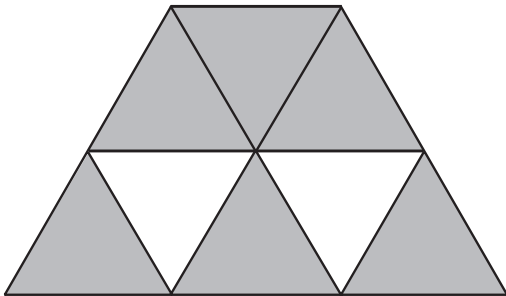
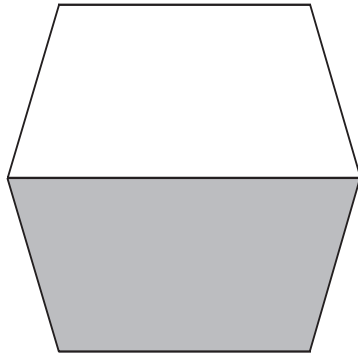
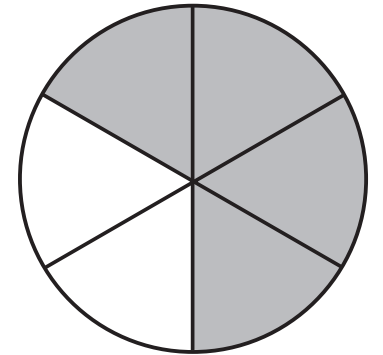
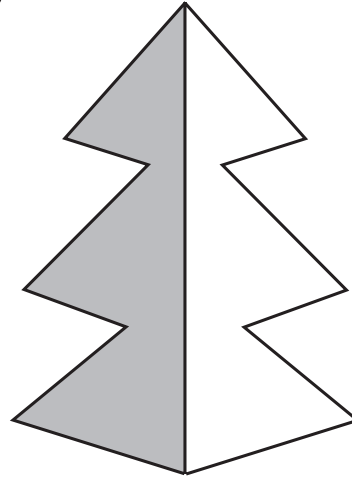
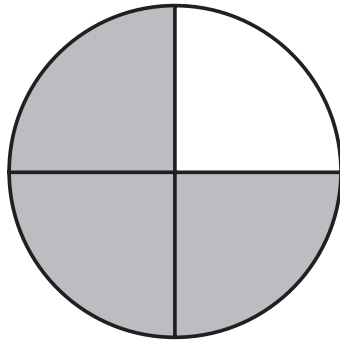
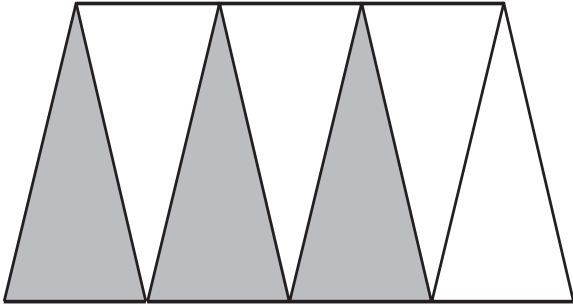

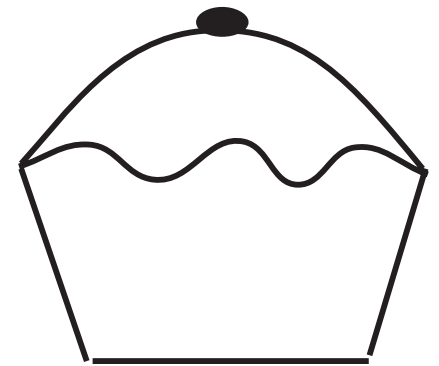
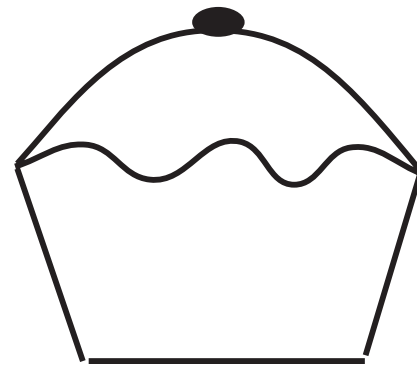
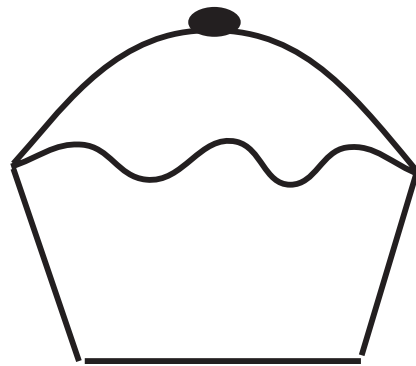
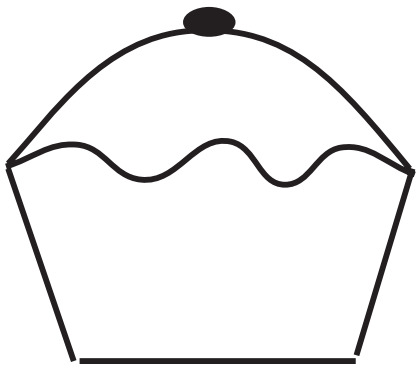
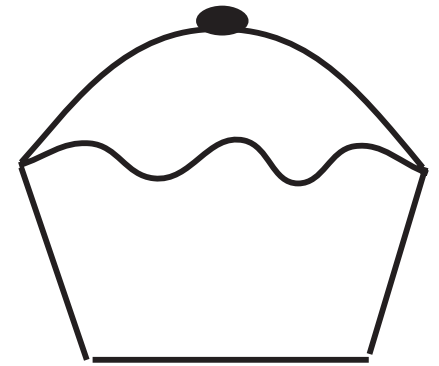
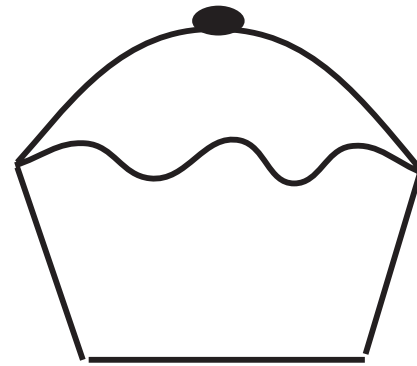
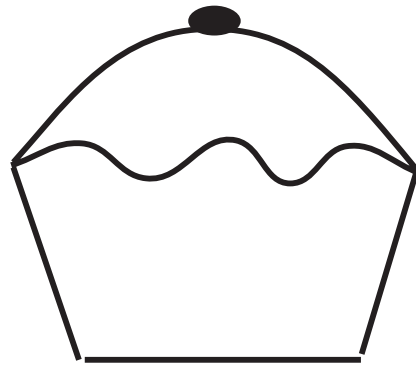
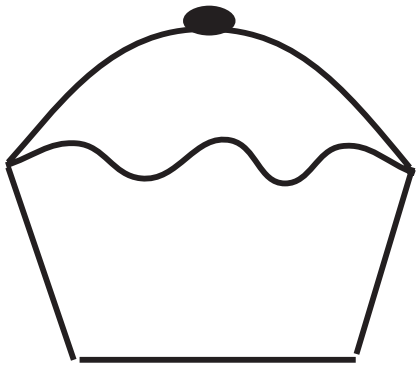
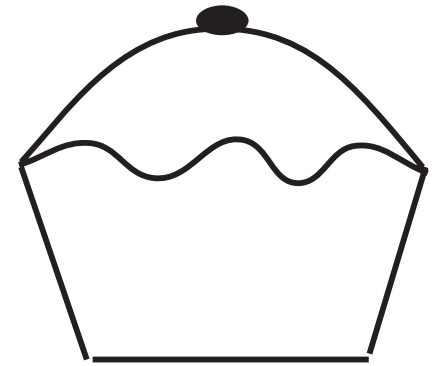
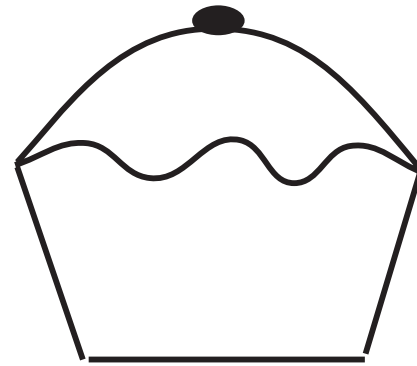
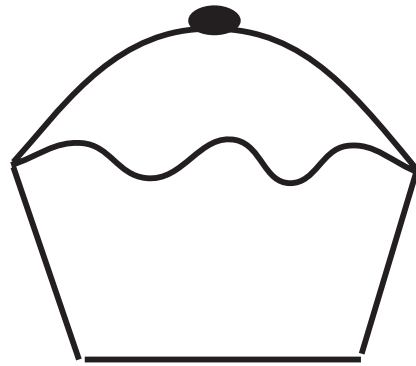
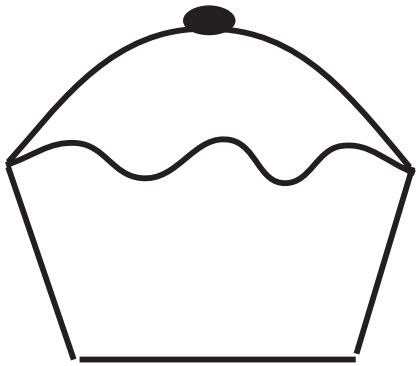

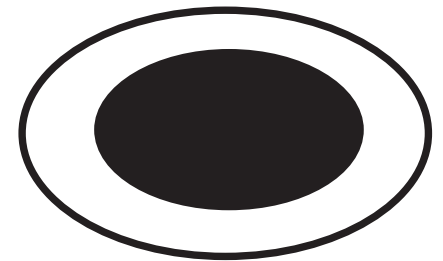
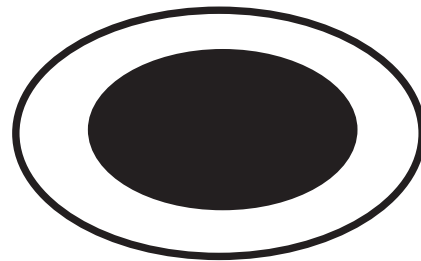
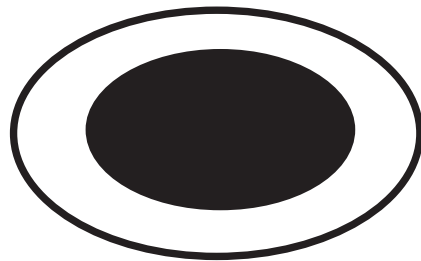
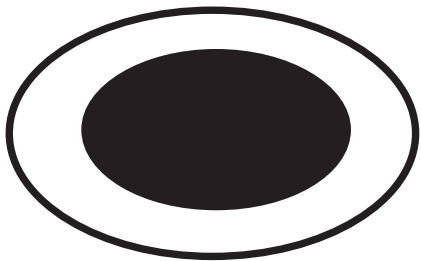
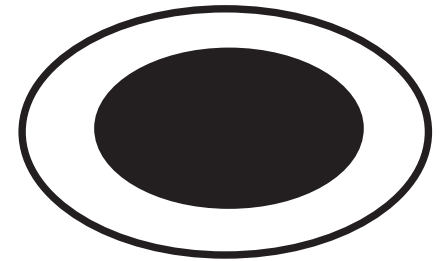
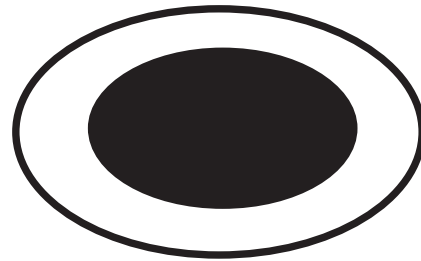
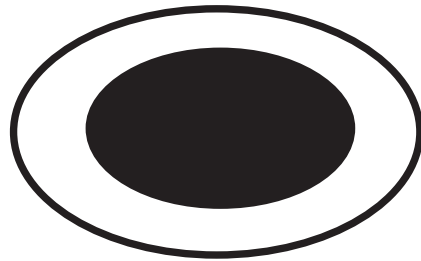
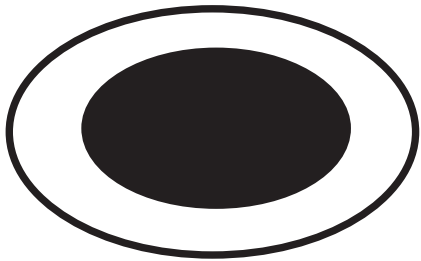
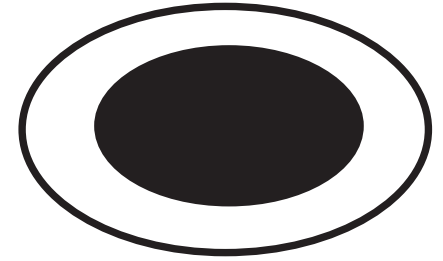
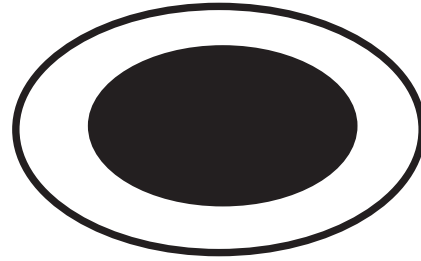
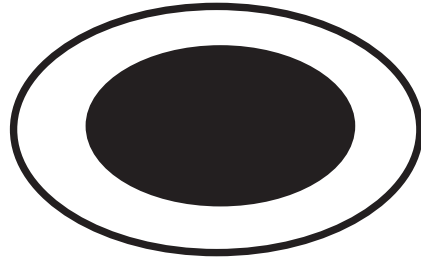
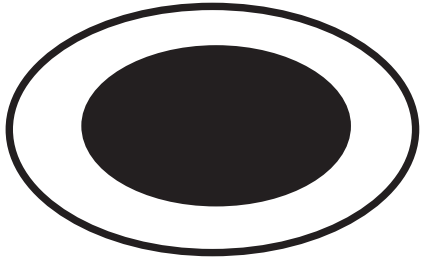
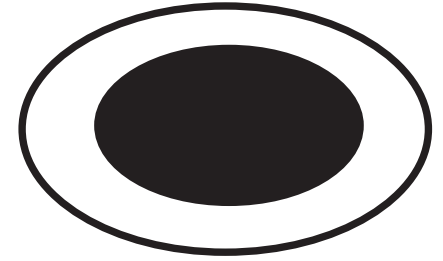
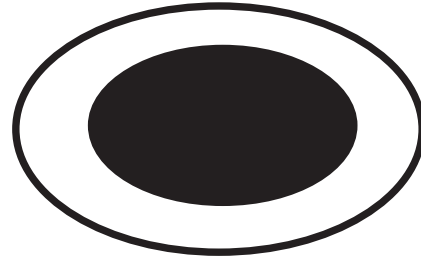
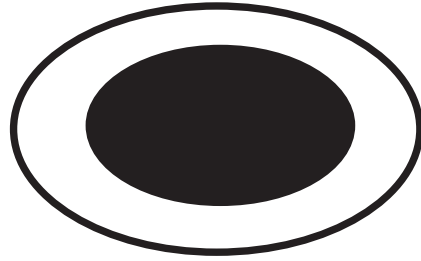
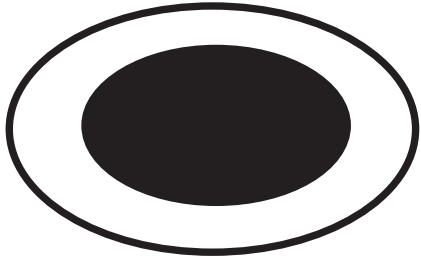

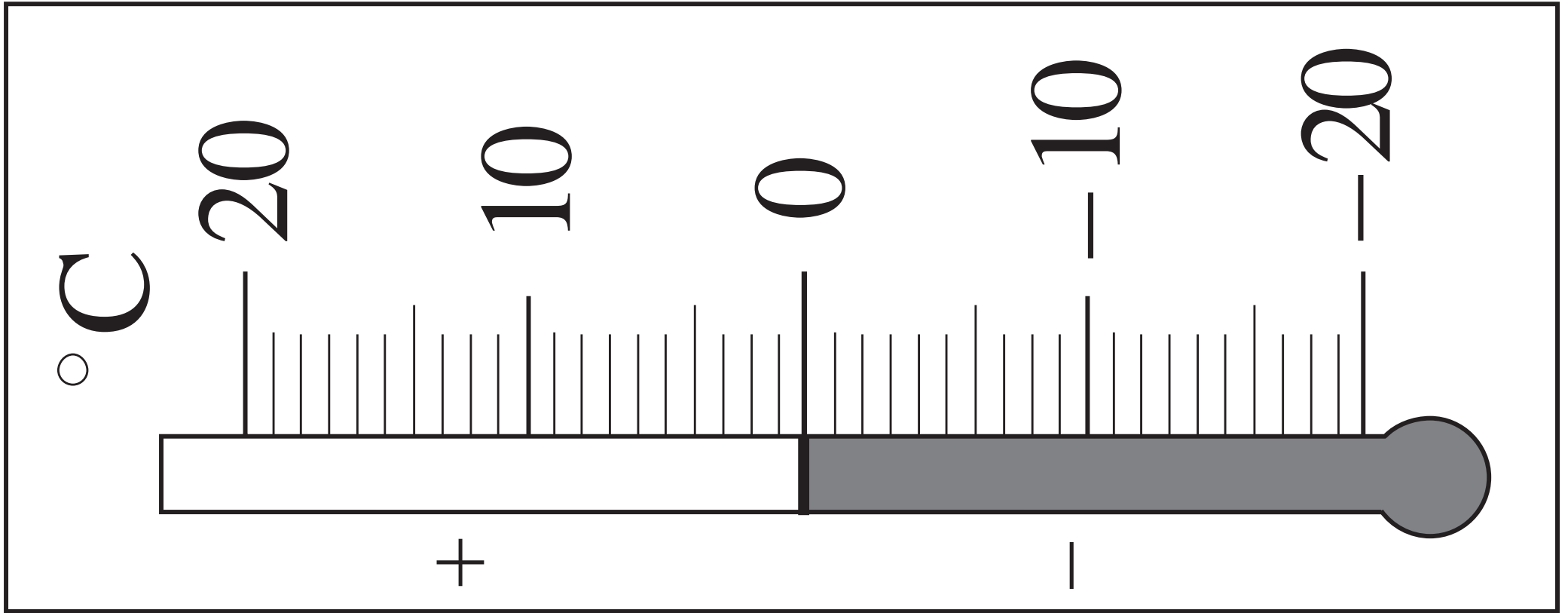

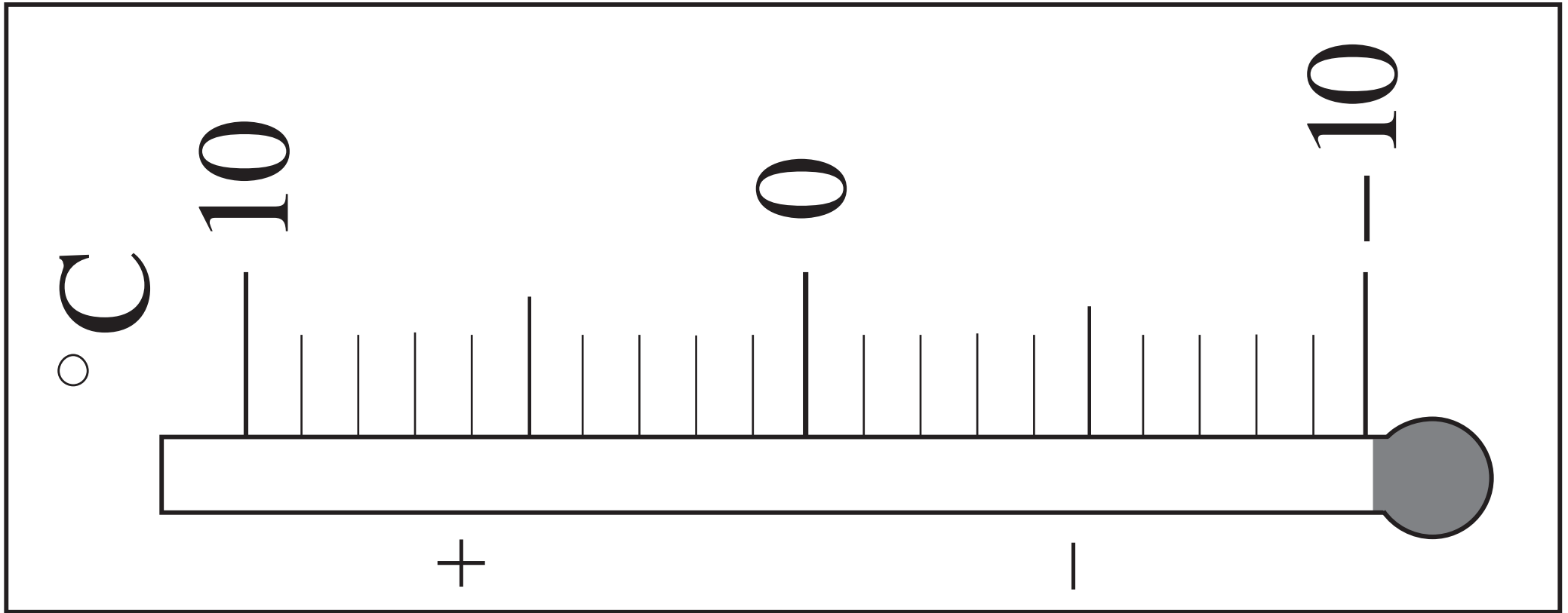

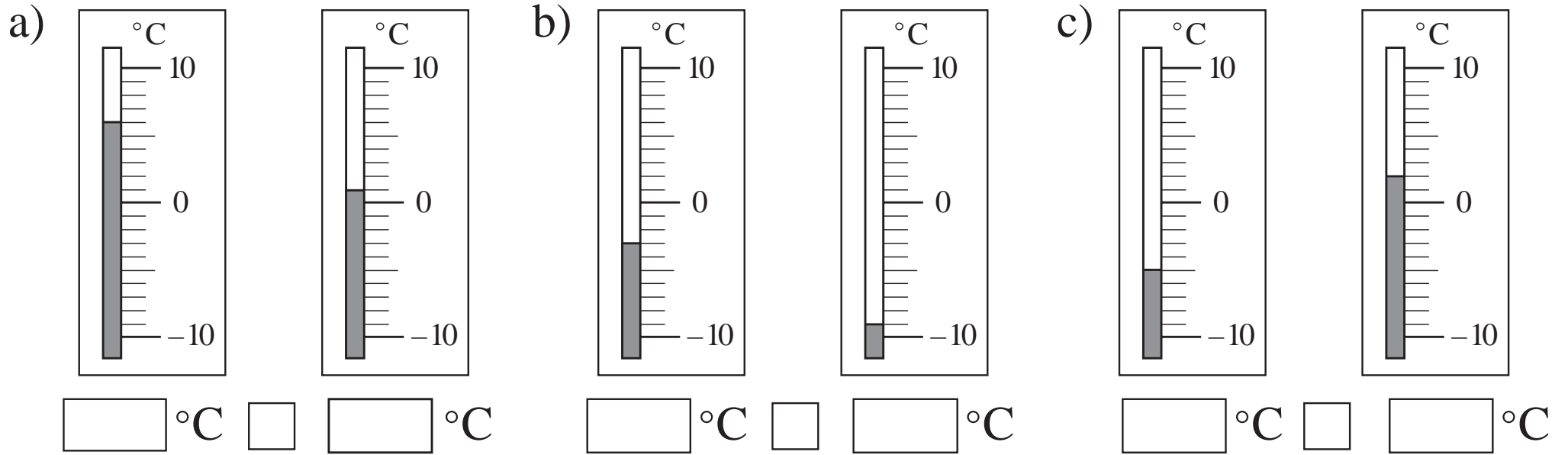

LP 128/3

B.C.

A.D.

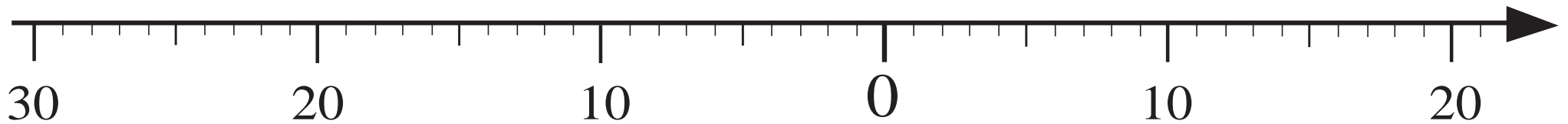

LP 128/5

a) Ann

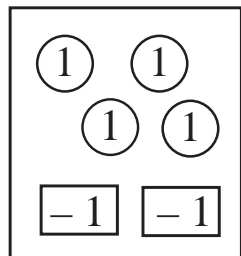

Paul

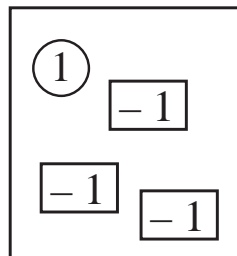

b) Ben

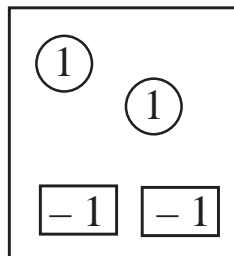

Rose

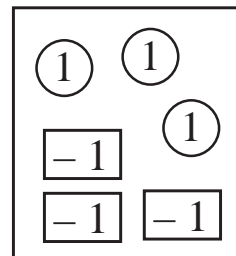

c) Colin

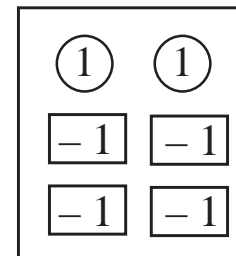

Sonia

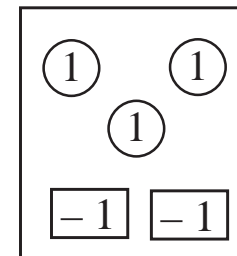

LP 128/8

a) Alice's balance is $-\pounds 6$: $(1) (1) [-1] [-1] [-1] [-1] [-1] [-1]$

b) Barry's balance is $\pounds 3$: $(1) (1) (1) [-1] [-1]$

c) Carol's balance is $\pounds 0$: $(1) (1) (1) (1) [-1] [-1] [-1] [-1]$

d) Dan's balance is $-\pounds 4$: $(1) (1) (1)$

e) Eve's balance is $\pounds 5$: $(1) (1) (1) (1) (1) (1)$

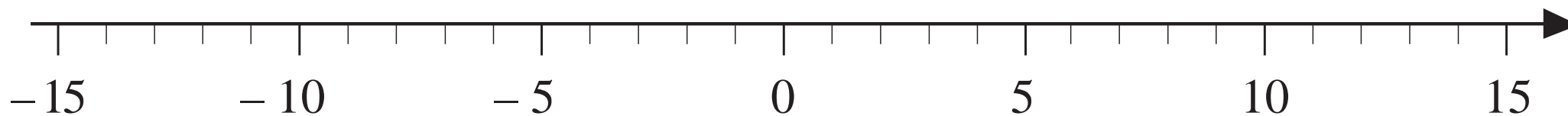
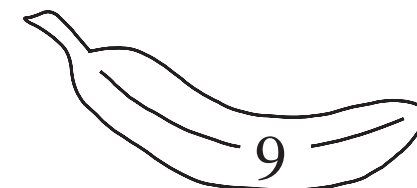
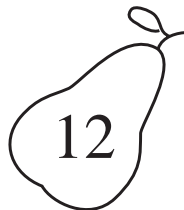
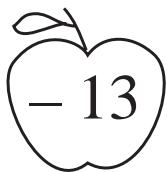

LP 129/3

Time (hours)	7	8	9	10	11	12	13	14	15	16	17	18	19
Temperature (°C)	-9	-10	-6	-2	0	3	6	8	9	7	4	-1	-3

LP 129/8a

Lisa

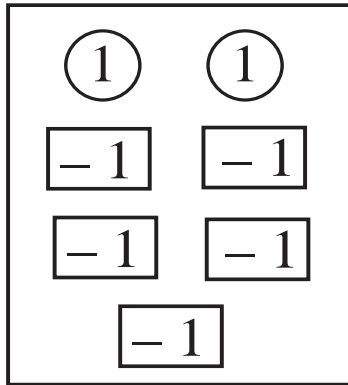

Charlie

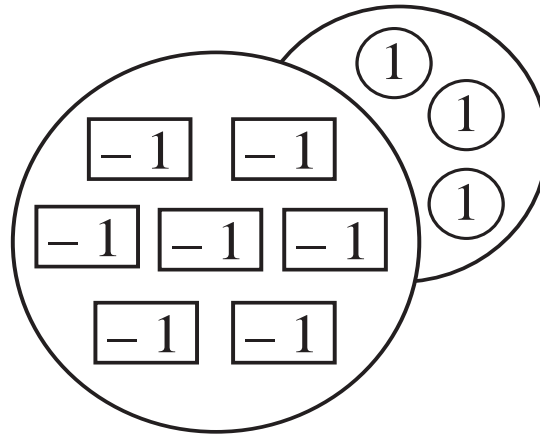

Billy

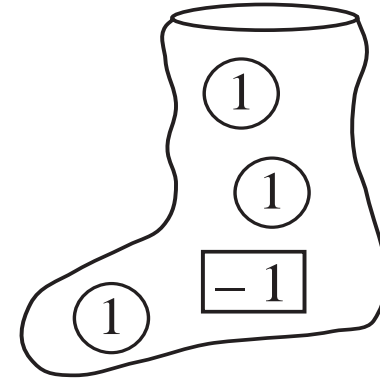

Clare

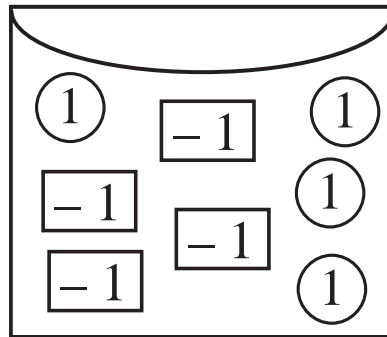

Diane

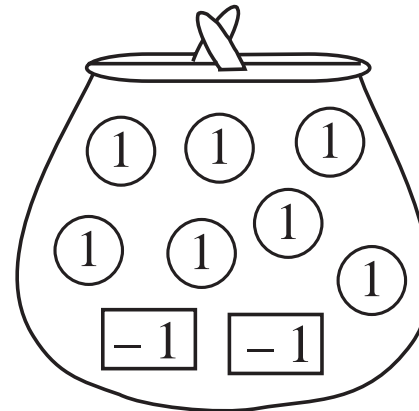

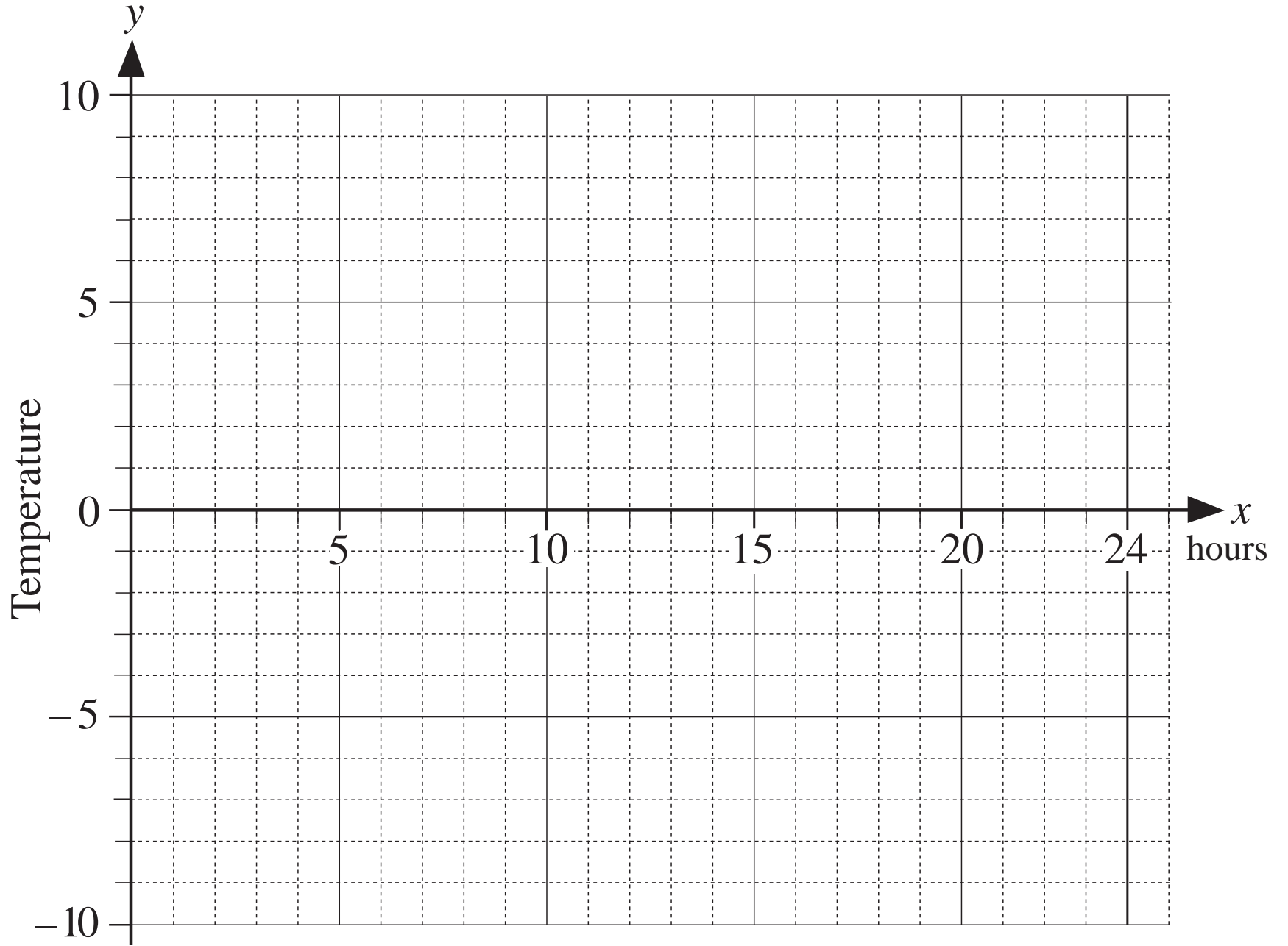
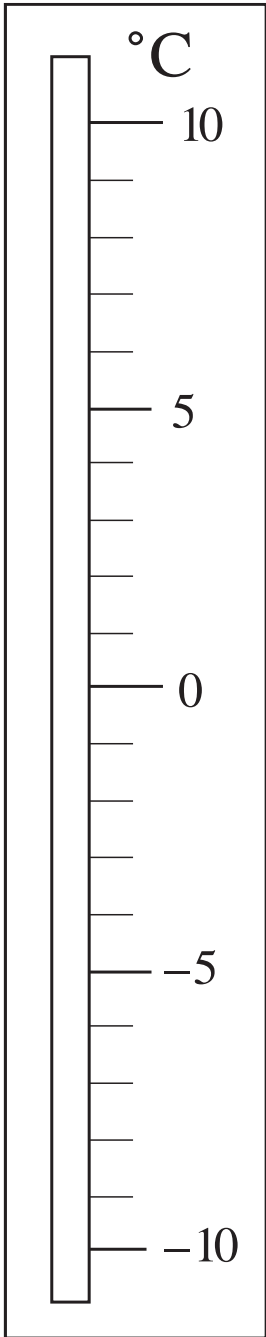

$$\text{a) } -3 < -9$$
$$6$$

$$\text{b) } -15 < -11$$
$$4$$

$$\text{c) } -8 < -2$$
$$10$$

$$\text{d) } -5 < 3$$
$$2$$

$$\text{e) } -2 > 1$$
$$1$$

$$\text{f) } -20 < 10$$
$$30$$

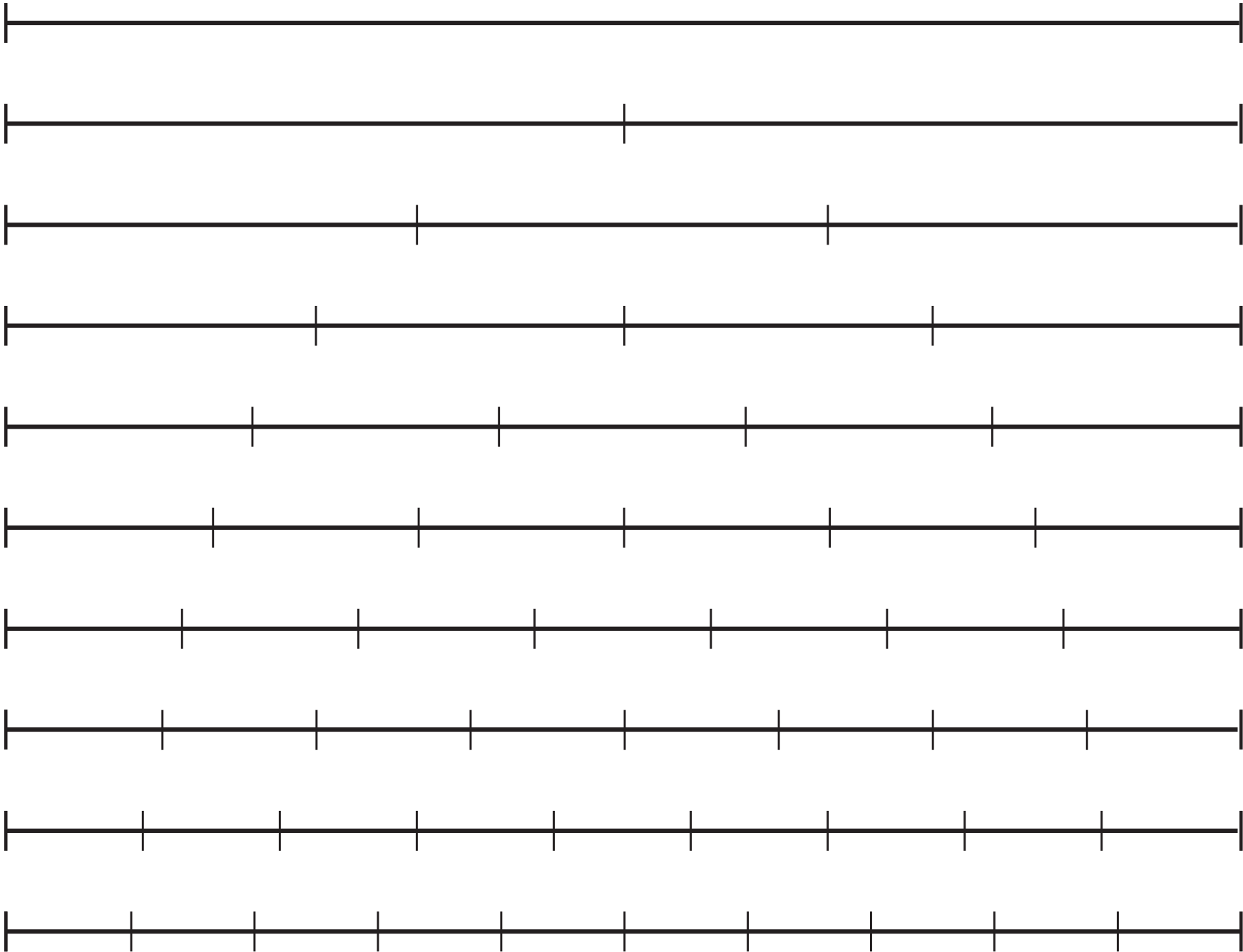

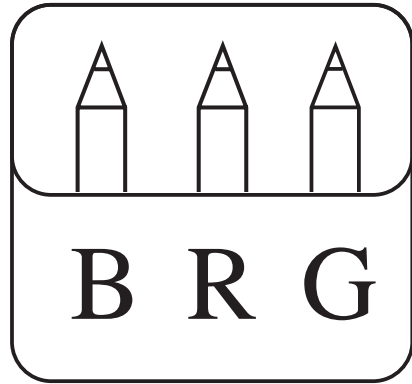

LP 131/4

50	50	50	50	50	50	50	50	50	50	}	}	}	}
50	50	50	50	50	50	50	50	50	50				
50	50	50	50	50	50	50	50	50	50				
50	50	50	50	50	50	50	50	50	50				
}					}								
}					}								
}					}								
}					}								
}					}								
}													

LP 131/6

a) $\textcircled{1}$ $\textcircled{1}$ $\textcircled{1}$ $\textcircled{1}$
 $\textcircled{1}$ $\textcircled{1}$ $\textcircled{1}$ $\textcircled{1}$
 $\textcircled{1}$ $\textcircled{1}$ $\textcircled{1}$ $\textcircled{1}$

b) $\textcircled{10}$ $\textcircled{10}$ $\textcircled{10}$ $\textcircled{10}$
 $\textcircled{10}$ $\textcircled{10}$ $\textcircled{10}$ $\textcircled{10}$
 $\textcircled{10}$ $\textcircled{10}$ $\textcircled{10}$ $\textcircled{10}$

c) $\textcircled{100}$ $\textcircled{100}$ $\textcircled{100}$ $\textcircled{100}$
 $\textcircled{100}$ $\textcircled{100}$ $\textcircled{100}$ $\textcircled{100}$
 $\textcircled{100}$ $\textcircled{100}$ $\textcircled{100}$ $\textcircled{100}$

A:	<div style="display: flex; justify-content: space-around;"> <div style="border: 1px solid black; padding: 5px;">100</div> <div style="border: 1px solid black; padding: 5px;">100</div> </div>	<div style="border: 1px solid black; padding: 5px;">50</div>	<div style="display: flex; justify-content: space-around;"> <div style="border: 1px solid black; border-radius: 50%; padding: 5px;">5</div> <div style="border: 1px solid black; border-radius: 50%; padding: 5px;">2</div> </div>	}	$3 \times ($ <div style="border: 1px solid black; display: inline-block; width: 40px; height: 20px; vertical-align: middle;"></div> $+$ <div style="border: 1px solid black; display: inline-block; width: 40px; height: 20px; vertical-align: middle;"></div> $+$ <div style="border: 1px solid black; display: inline-block; width: 40px; height: 20px; vertical-align: middle;"></div> $)$
B:	<div style="display: flex; justify-content: space-around;"> <div style="border: 1px solid black; padding: 5px;">100</div> <div style="border: 1px solid black; padding: 5px;">100</div> </div>	<div style="border: 1px solid black; padding: 5px;">50</div>	<div style="display: flex; justify-content: space-around;"> <div style="border: 1px solid black; border-radius: 50%; padding: 5px;">5</div> <div style="border: 1px solid black; border-radius: 50%; padding: 5px;">2</div> </div>		
C:	<div style="display: flex; justify-content: space-around;"> <div style="border: 1px solid black; padding: 5px;">100</div> <div style="border: 1px solid black; padding: 5px;">100</div> </div>	<div style="border: 1px solid black; padding: 5px;">50</div>	<div style="display: flex; justify-content: space-around;"> <div style="border: 1px solid black; border-radius: 50%; padding: 5px;">5</div> <div style="border: 1px solid black; border-radius: 50%; padding: 5px;">2</div> </div>		
	$\underbrace{\hspace{10em}}$	$\underbrace{\hspace{10em}}$	$\underbrace{\hspace{10em}}$		
	$3 \times$ <div style="border: 1px solid black; display: inline-block; width: 40px; height: 20px; vertical-align: middle;"></div>	$+$ $3 \times$ <div style="border: 1px solid black; display: inline-block; width: 40px; height: 20px; vertical-align: middle;"></div>	$+$ $3 \times$ <div style="border: 1px solid black; display: inline-block; width: 40px; height: 20px; vertical-align: middle;"></div>	$=$	<div style="border-top: 1px dashed black; width: 100%; height: 10px;"></div>
	$\underbrace{\hspace{10em}}$	$\underbrace{\hspace{10em}}$	$\underbrace{\hspace{10em}}$		
	<div style="border: 1px solid black; width: 40px; height: 20px; margin: 0 auto;"></div>	<div style="border: 1px solid black; width: 40px; height: 20px; margin: 0 auto;"></div>	<div style="border: 1px solid black; width: 40px; height: 20px; margin: 0 auto;"></div>		

5×1

$50 \div 5$

4×3

$21 \div 3$

$25 \div 5$

10×2

$40 \div 4$

2×6

$42 \div 6$

10×10

7×5

$6 \div 2$

9×2

$63 \div 9$

$27 \div 3$

5×9

$80 \div 8$

7×3

$18 \div 6$

4×8

5×2

$35 \div 5$

6×7

$18 \div 9$

$56 \div 8$

2×3

$8 \div 2$

7×9

$18 \div 3$

10×0

a) $\textcircled{2}$ $\textcircled{2}$ $\textcircled{2}$

$\textcircled{20}$ $\textcircled{20}$ $\textcircled{20}$

$\textcircled{200}$ $\textcircled{200}$ $\textcircled{200}$

b) $\textcircled{2}$ $\textcircled{2}$ $\textcircled{2}$
 $\textcircled{2}$ $\textcircled{2}$ $\textcircled{2}$

$\textcircled{20}$ $\textcircled{20}$ $\textcircled{20}$
 $\textcircled{20}$ $\textcircled{20}$ $\textcircled{20}$

$\textcircled{200}$ $\textcircled{200}$ $\textcircled{200}$
 $\textcircled{200}$ $\textcircled{200}$ $\textcircled{200}$

a)

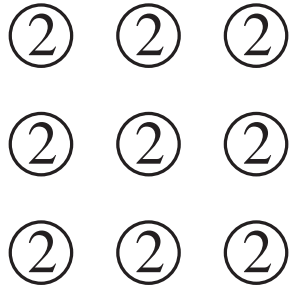

b)

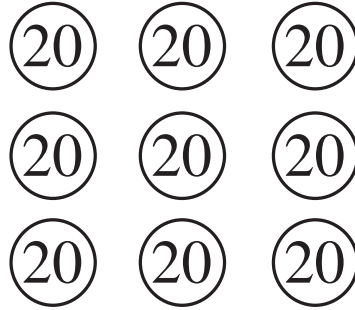

c)

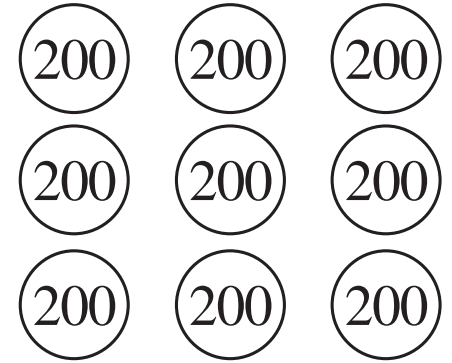

a) $5 \times 3 = \square$ $50 \times 3 = \square$ $5 \times 30 = \square$ $5 \times 300 = \square$ $50 \times 30 = \square$

b) $8 \times 2 = \square$ $80 \times 2 = \square$ $8 \times 20 = \square$ $8 \times 200 = \square$ $80 \times 20 = \square$

c) $3 \times 3 = \square$ $30 \times 3 = \square$ $3 \times 30 = \square$ $3 \times 300 = \square$ $30 \times 30 = \square$

d) $4 \times 5 = \square$ $40 \times 5 = \square$ $4 \times 50 = \square$ $4 \times 500 = \square$ $40 \times 50 = \square$

LP 132/7a

a) $5 \times 3 = \boxed{15}$ $50 \times 3 = \boxed{150}$ $5 \times 30 = \boxed{150}$ $5 \times 300 = \boxed{1500}$ $50 \times 30 = \boxed{1500}$

b) $8 \times 2 = \boxed{16}$ $80 \times 2 = \boxed{160}$ $8 \times 20 = \boxed{160}$ $8 \times 200 = \boxed{1600}$ $80 \times 20 = \boxed{1600}$

c) $3 \times 3 = \boxed{9}$ $30 \times 3 = \boxed{90}$ $3 \times 30 = \boxed{90}$ $3 \times 300 = \boxed{900}$ $30 \times 30 = \boxed{900}$

d) $4 \times 5 = \boxed{20}$ $40 \times 5 = \boxed{200}$ $4 \times 50 = \boxed{200}$ $4 \times 500 = \boxed{2000}$ $40 \times 50 = \boxed{2000}$

LP 132/7b

John

⑩ ②

⑩ ②

⑩ ②

⑩ ②

Katy

①①① ②②

①①① ②②

①①① ②②

①①① ②②

Lorna

⑤① ② ①

⑤① ② ①

⑤① ② ①

Michael

⑤①① ②① ①①

⑤①① ②① ①①

⑤①① ②① ①①

John:

.....

Katy:

.....

Lorna:

.....

Michael:

.....

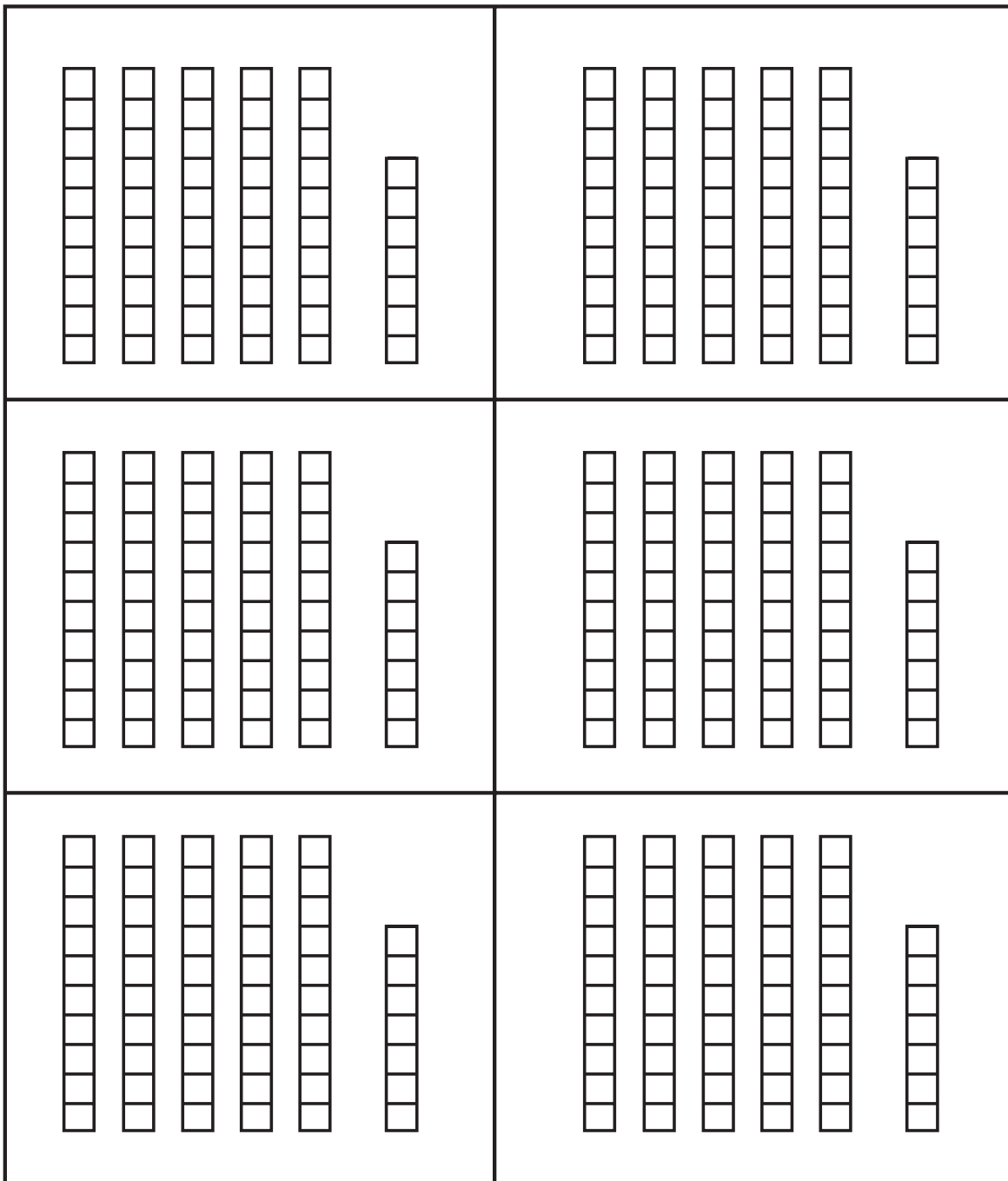

$$\begin{array}{|c|c|} \hline & \\ \hline \end{array} \times \begin{array}{|c|} \hline \\ \hline \end{array} =$$

$$\begin{array}{|c|c|} \hline & \\ \hline \end{array} \times \begin{array}{|c|} \hline \\ \hline \end{array} + \begin{array}{|c|} \hline \\ \hline \end{array} \times \begin{array}{|c|} \hline \\ \hline \end{array}$$

$$= \begin{array}{|c|c|c|} \hline & & \\ \hline \end{array} + \begin{array}{|c|c|} \hline & \\ \hline \end{array}$$

$$= \begin{array}{|c|c|c|} \hline & & \\ \hline \end{array}$$

$$\begin{array}{|c|c|} \hline & \\ \hline \end{array} \times \begin{array}{|c|} \hline \\ \hline \end{array} = \begin{array}{|c|c|c|} \hline & & \\ \hline \end{array}$$

a) $40 \times 3 = \square$ $40 \times 6 = \square$ $40 \times 12 = \square$

b) $30 \times 4 = \square$ $30 \times 8 = \square$ $30 \times 12 = \square$

c) $50 \times 2 = \square$ $50 \times 6 = \square$ $50 \times 20 = \square$

$$\text{a) } 6 \times 28 = \square \quad 3 \times 28 = \square \quad 6 \times 14 = \square$$

$$6 \times 280 = \square \quad 3 \times 280 = \square \quad 6 \times 140 = \square$$

$$\text{b) } 4 \times 16 = \square \quad 8 \times 8 = \square \quad 2 \times 32 = \square$$

$$4 \times 160 = \square \quad 8 \times 80 = \square \quad 2 \times 320 = \square$$

$$\text{c) } 6 \times 16 = \square \quad 6 \times 15 = \square \quad 5 \times 15 = \square$$

$$6 \times 160 = \square \quad 6 \times 150 = \square \quad 5 \times 150 = \square$$

a) 227×4

i) Rounding 227 to the nearest hundred:

$$P \approx \boxed{} \times 4 = \boxed{} \quad P \bigcirc \boxed{}$$

ii) Rounding 227 to the nearest ten:

$$P \approx \boxed{} \times 4 = \boxed{} \quad P \bigcirc \boxed{}$$

b) 468×6

i) Rounding 468 to the nearest hundred:

$$P \approx \boxed{} \times 6 = \boxed{} \quad P \bigcirc \boxed{}$$

ii) Rounding 468 to the nearest ten:

$$P \approx \boxed{} \times 6 = \boxed{} \quad P \bigcirc \boxed{}$$

a) $162 \times 5 \approx \square \times 5 = \square$ $162 \times 5 \bigcirc \square$

b) $177 \times 4 \approx \square \times 4 = \square$ $177 \times 4 \bigcirc \square$

c) $315 \times 3 \approx \square \times 3 = \square$ $315 \times 3 \bigcirc \square$

d) $231 \times 4 \approx \square \times 4 = \square$ $231 \times 4 \bigcirc \square$

100

100

20

10

20

10

5

5

Make two copies on card.

a)

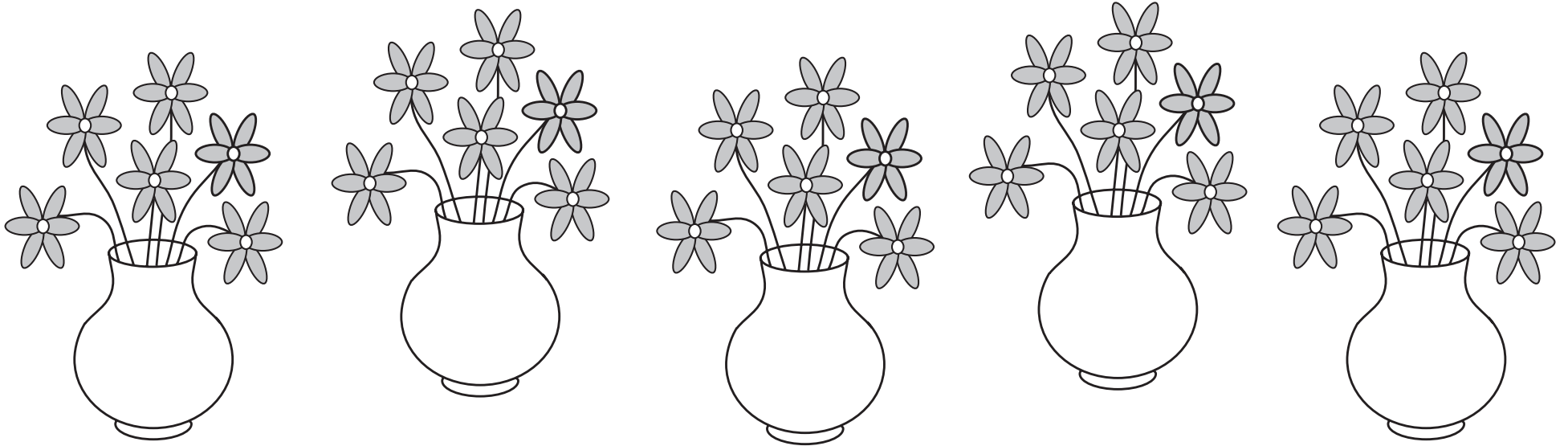

b)

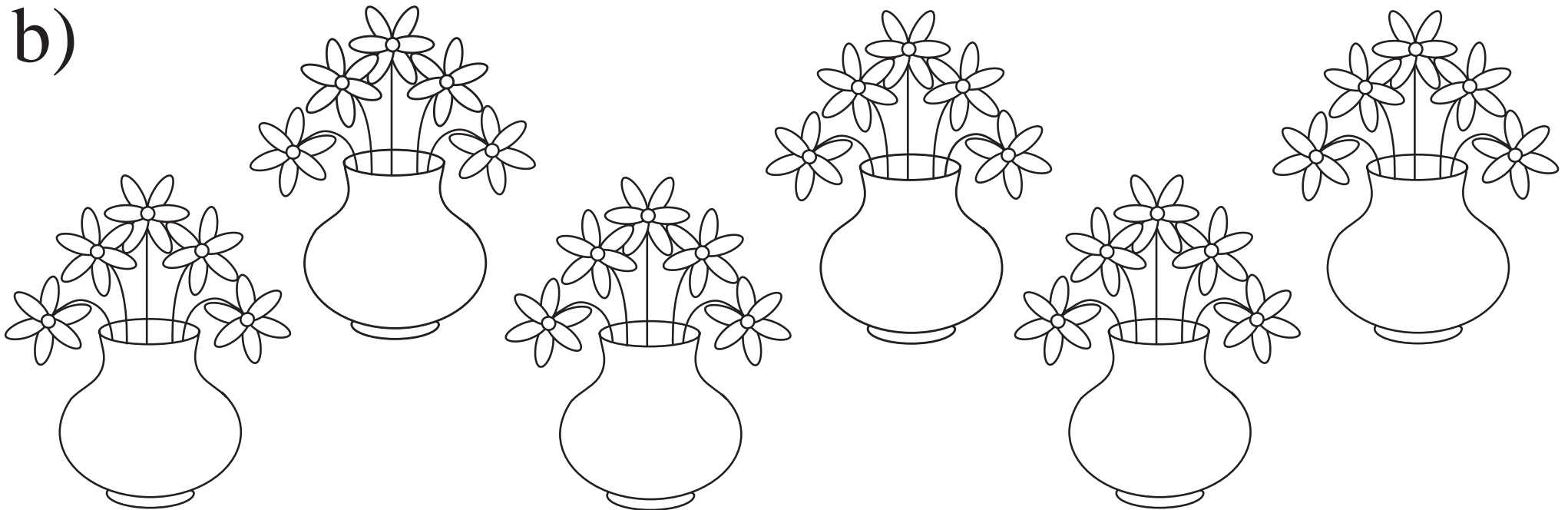

$$436 \times 5$$

$$436 \times 5$$

$$436 \times 5$$

$$436 \times 5$$

1800

2000

2400

2100

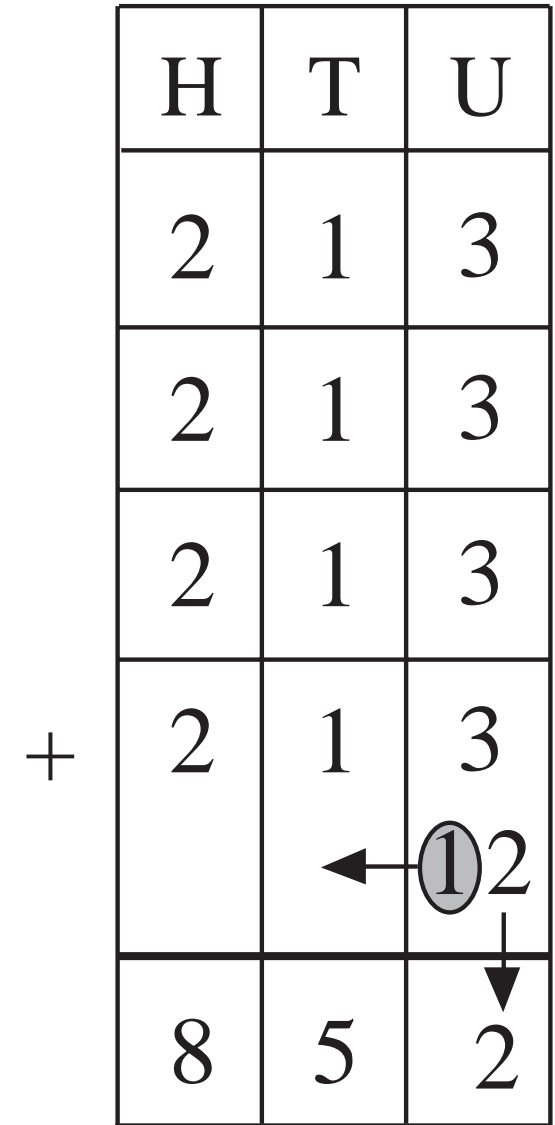
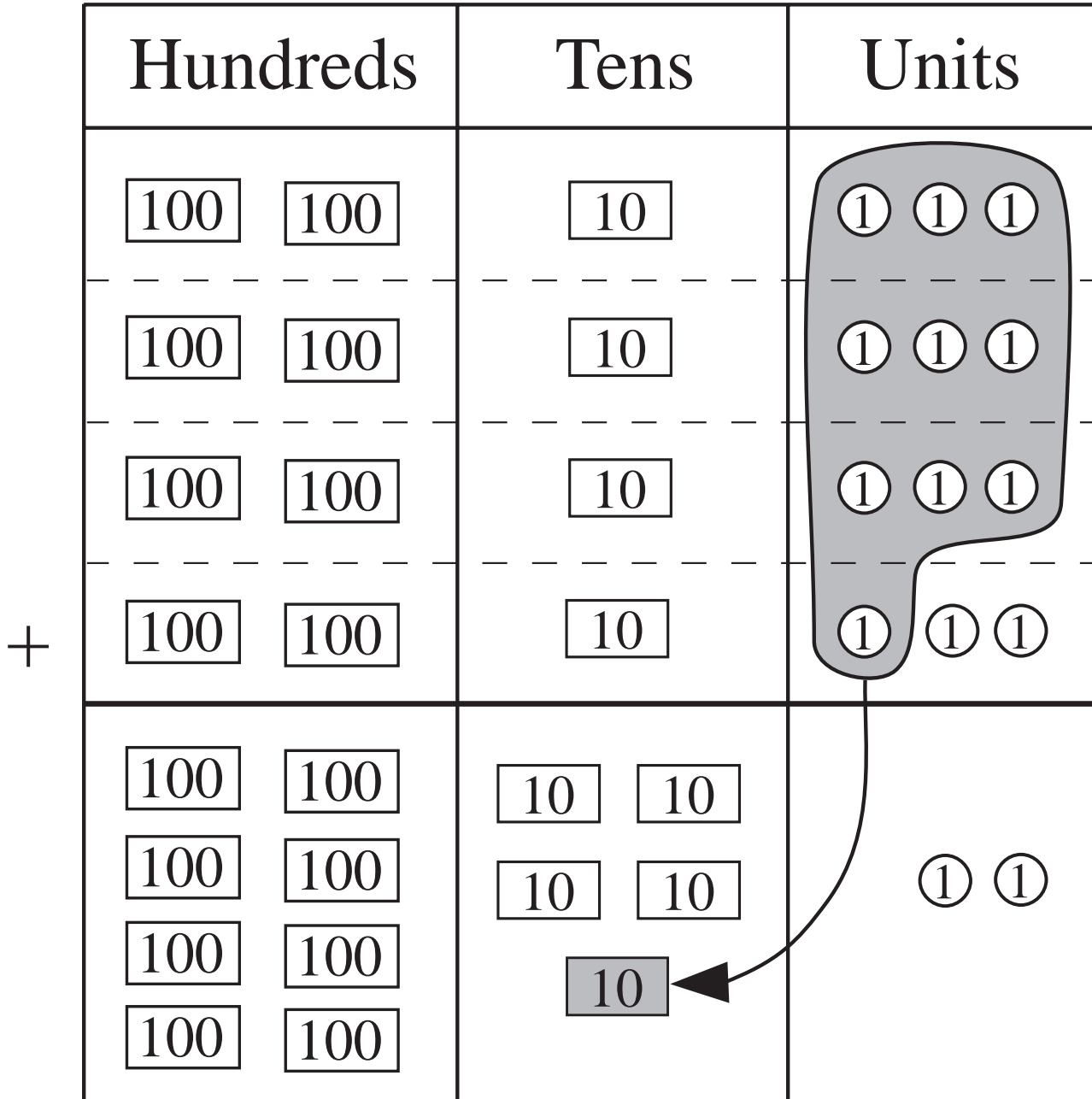

	H	T	U
	2	1	3
	2	1	3
	2	1	3
+	2	1	3
	8	5	2

H	T	U	
2	1	3	× 4
8	5	2	

2	1	3	× 4
8	5	2	

Hundreds	Tens	Units
100		

H	T	U

+

H	T	U

 $\times 3$

 $\times 3$

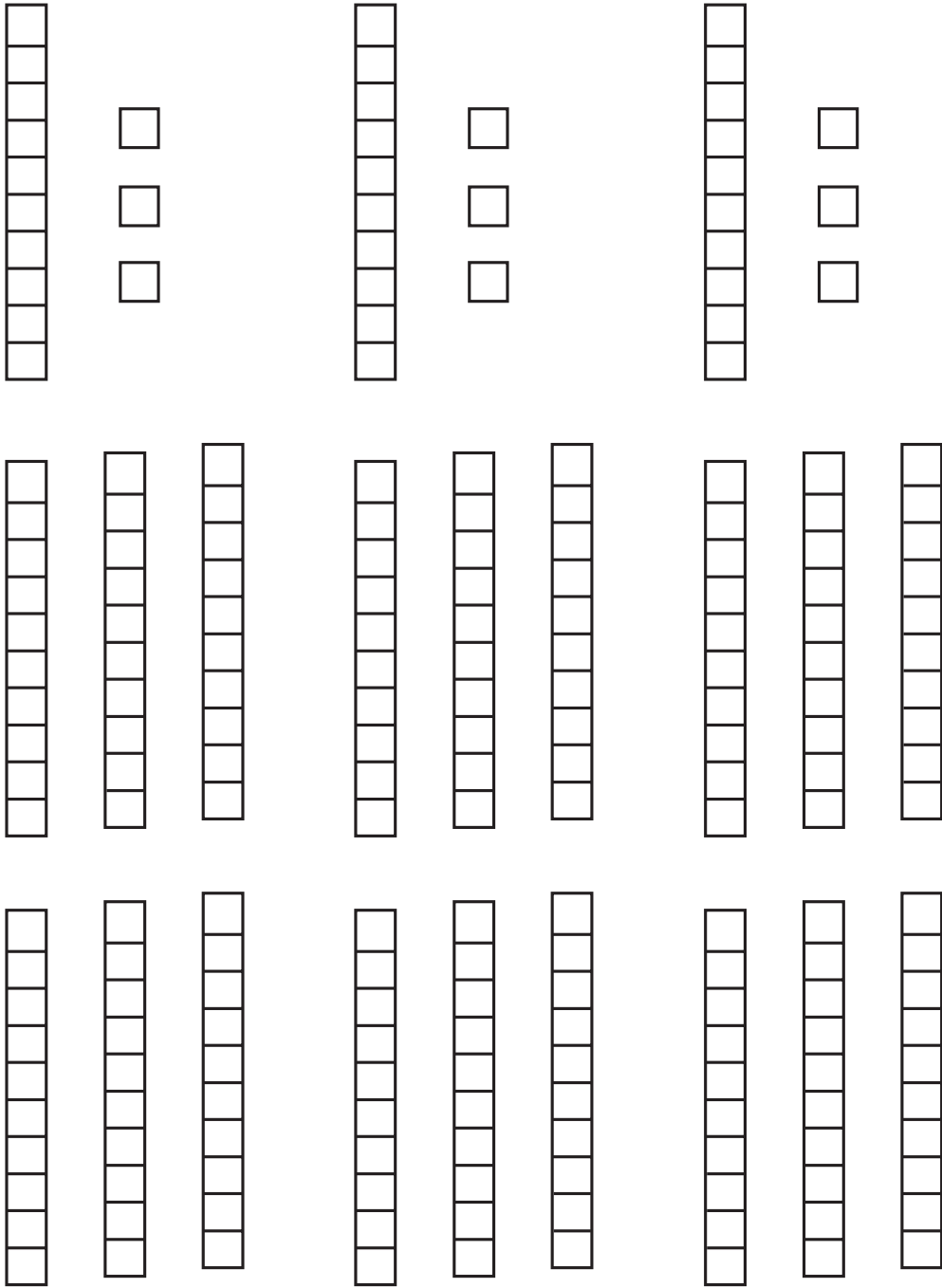

$$73 \times 3 = \begin{array}{|c|c|c|} \hline & & \\ \hline & & \\ \hline & & \\ \hline \end{array}$$

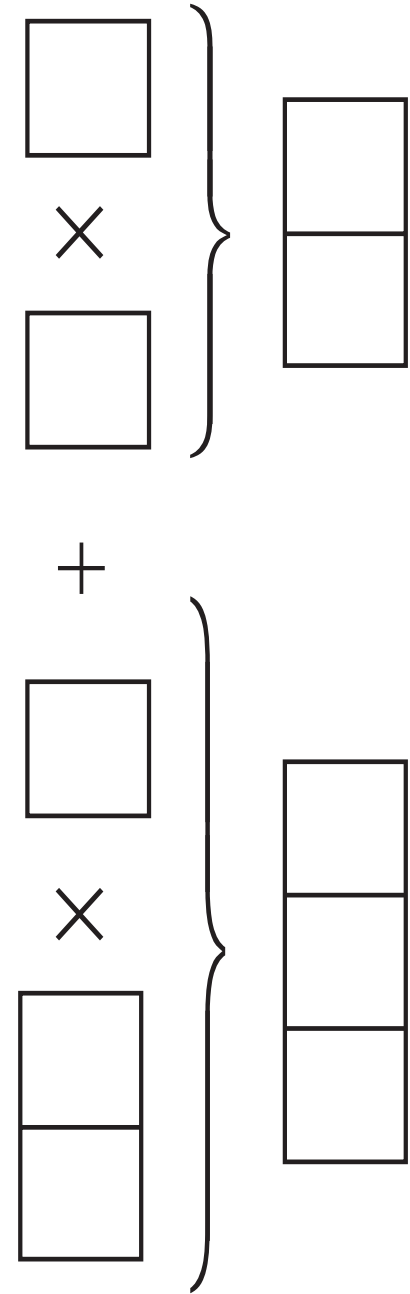

a)

	2	0	2
	2	0	2
	2	0	2
+	2	0	2
<hr/>			

E:

--	--	--	--

	2	0	2	×	
<hr/>					

b)

	3	0	2
	3	0	2
+	3	0	2
<hr/>			

E:

--	--	--	--

	3	0	2	×	
<hr/>					

c)

	4	2	3
+	4	2	3
<hr/>			

E:

--	--	--	--

	4	2	3	×	
<hr/>					

d)

	2	0	1
	2	0	1
	2	0	1
	2	0	1
+	2	0	1
<hr/>			

E:

--	--	--	--

	2	0	1	×	
<hr/>					

a)

H	T	U		
	8	2	×	4

b)

H	T	U		
	9	1	×	7

c)

H	T	U		
	6	2	×	3

d)

H	T	U		
	6	2	×	4

e)

H	T	U		
	9	1	×	8

f)

H	T	U		
	1	2	×	4

g)

Th	H	T	U		
	3	2	1	×	3

h)

Th	H	T	U		
	3	2	1	×	4

i)

Th	H	T	U		
	5	2	3	×	3

j)

Th	H	T	U		
	4	0	2	×	4

k)

Th	H	T	U		
	4	0	3	×	4

l)

Th	H	T	U		
	6	1	2	×	3

<i>a</i>	423	211	322	323	514	73	441
<i>b</i>	2	5	4	3			
<i>c</i>	846	1055			1028	219	882

a) *E*:

	4	2	3
	4	2	3
+	4	2	3

	4	2	3	×	

 b) *E*:

	3	2	1
	3	2	1
	3	2	1
+	3	2	1

	3	2	1	×	

 c) *E*:

	3	0	9
	3	0	9
+	3	0	9

	3	0	9	×	

 d) *E*:

	1	4	1
	1	4	1
	1	4	1
	1	4	1
	1	4	1
	1	4	1
+	1	4	1

	1	4	1	×	

a)

	7	1
	7	1
	7	1
	7	1
	7	1
+	7	1
<hr/>		

E:

	7	1	×	6
<hr/>				

b)

E:

	2	0	1
	2	0	1
	2	0	1
+	2	0	1
<hr/>			

2	0	1	×	
<hr/>				

c)

E:

	5	3	4
+	5	3	4
<hr/>			

	5	3	4	×	
<hr/>					

d)

E:

	2	1	1
	2	1	1
	2	1	1
	2	1	1
+	2	1	1
<hr/>			

2	1	1	×	
<hr/>				

a) *E:*

--	--	--

4	2	2	×	2

E:

--	--	--	--

	4	2	2	×	3

E:

--	--	--	--

	4	2	2	×	4

b) *E:*

--	--	--

3	2	1	×	3

E:

--	--	--	--

	4	2	1	×	3

E:

--	--	--	--

	6	2	1	×	3

c) *E:*

--	--	--

	8	4	×	2

E:

--	--	--	--

	8	0	4	×	2

E:

--	--	--	--

	4	0	2	×	4

Thousands	Hundreds	Tens	Units
	<div style="display: flex; flex-wrap: wrap; gap: 5px;"> <div style="border: 1px solid black; padding: 2px;">100</div> <div style="border: 1px solid black; padding: 2px;">100</div> <div style="border: 1px solid black; padding: 2px;">100</div> <div style="border: 1px solid black; padding: 2px;">100</div> <div style="border: 1px solid black; padding: 2px;">100</div> </div>	<div style="display: flex; flex-wrap: wrap; gap: 5px;"> <div style="border: 1px solid black; padding: 2px;">10</div> <div style="border: 1px solid black; padding: 2px;">10</div> <div style="border: 1px solid black; padding: 2px;">10</div> </div>	<div style="display: flex; flex-wrap: wrap; gap: 5px;"> <div style="border: 1px solid black; border-radius: 50%; padding: 2px;">1</div> <div style="border: 1px solid black; border-radius: 50%; padding: 2px;">1</div> <div style="border: 1px solid black; border-radius: 50%; padding: 2px;">1</div> <div style="border: 1px solid black; border-radius: 50%; padding: 2px;">1</div> <div style="border: 1px solid black; border-radius: 50%; padding: 2px;">1</div> <div style="border: 1px solid black; border-radius: 50%; padding: 2px;">1</div> </div>
	<div style="display: flex; flex-wrap: wrap; gap: 5px;"> <div style="border: 1px solid black; padding: 2px;">100</div> <div style="border: 1px solid black; padding: 2px;">100</div> <div style="border: 1px solid black; padding: 2px;">100</div> <div style="border: 1px solid black; padding: 2px;">100</div> <div style="border: 1px solid black; padding: 2px;">100</div> </div>	<div style="display: flex; flex-wrap: wrap; gap: 5px;"> <div style="border: 1px solid black; padding: 2px;">10</div> <div style="border: 1px solid black; padding: 2px;">10</div> <div style="border: 1px solid black; padding: 2px;">10</div> </div>	<div style="display: flex; flex-wrap: wrap; gap: 5px;"> <div style="border: 1px solid black; border-radius: 50%; padding: 2px;">1</div> <div style="border: 1px solid black; border-radius: 50%; padding: 2px;">1</div> <div style="border: 1px solid black; border-radius: 50%; padding: 2px;">1</div> <div style="border: 1px solid black; border-radius: 50%; padding: 2px;">1</div> <div style="border: 1px solid black; border-radius: 50%; padding: 2px;">1</div> <div style="border: 1px solid black; border-radius: 50%; padding: 2px;">1</div> </div>

+

Th	H	T	U

+

Th	H	T	U

 ×

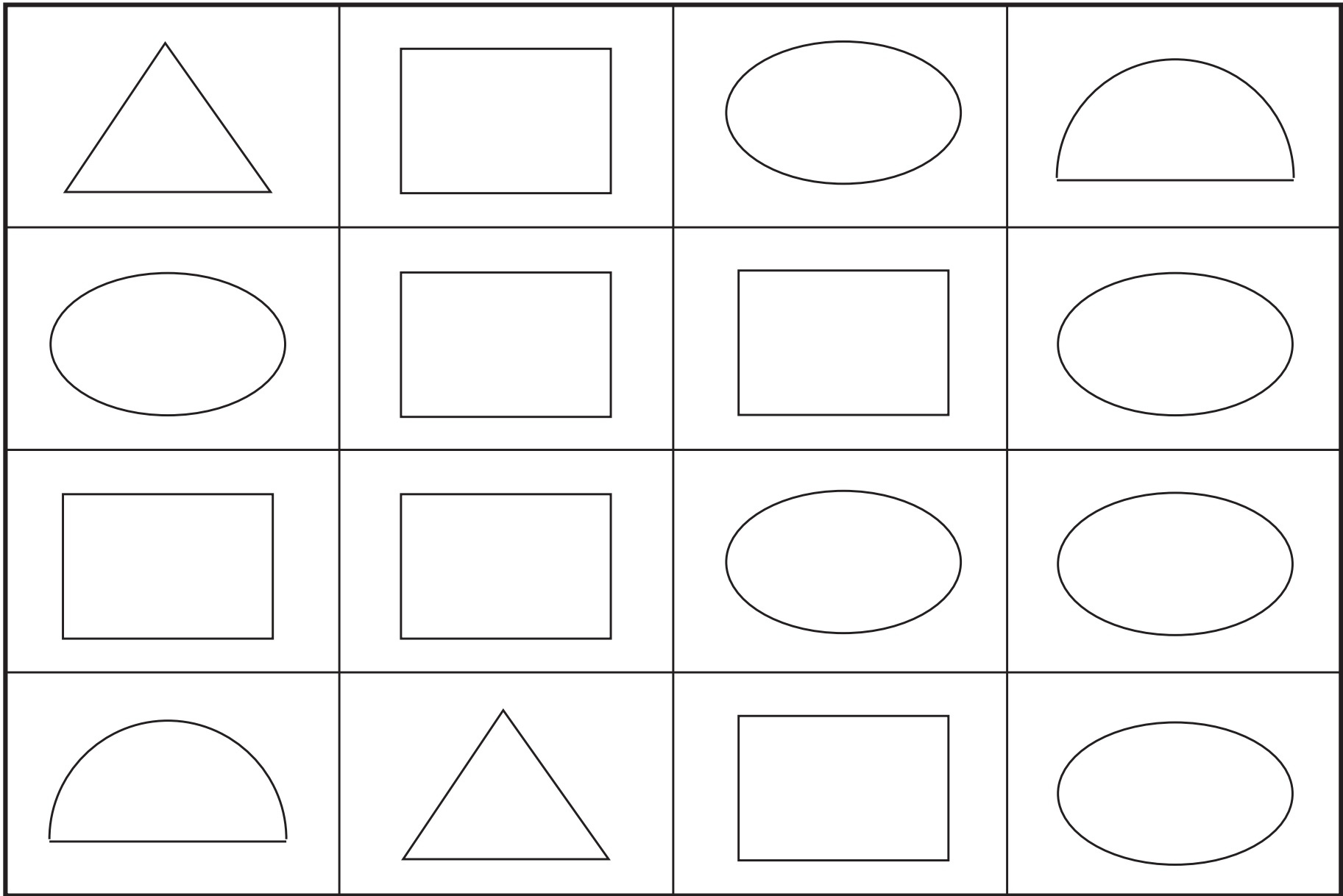

a	b	c	$a \times c$	$a \times b$	$b \times c$
400	5	3			
450	6	4			

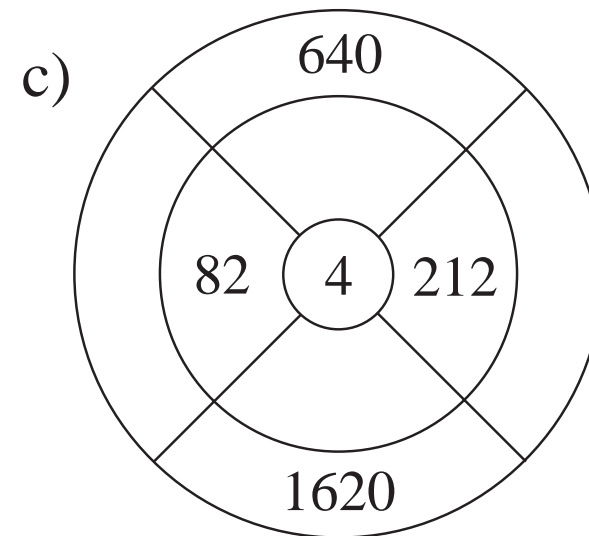
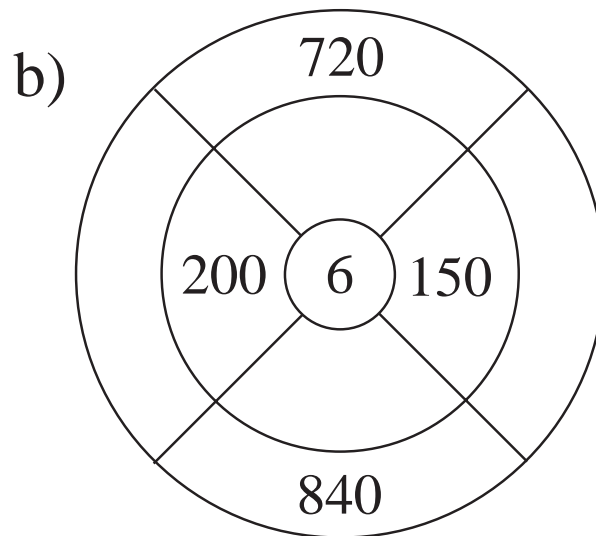
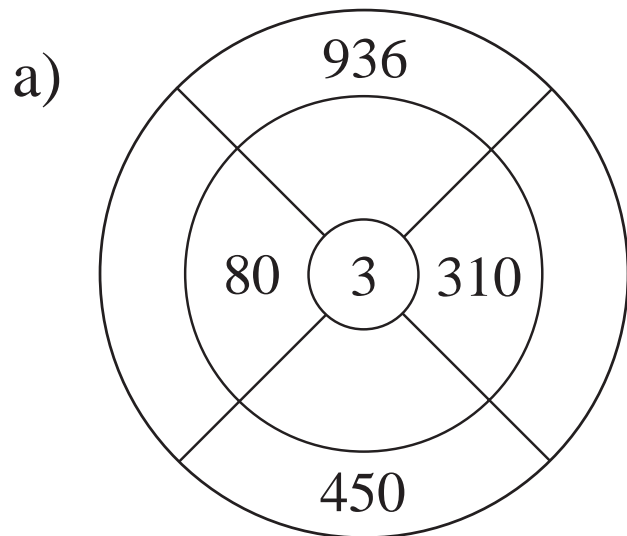

LP 138/4

a)

		6	4	×	3		
1	8	1	2				

b)

	5	0	2	×	3		
	1	5	6				

c)

	4	6	4	×	3		
1	3	9	2				

d)

	1	7	0	×	3		
5	1	3					

e)

	4	0	5	×	3		
2	2	1	5				

f)

	3	1	6	×	4		
1	2	4	4				

LP 138/5

a)

	2	6	×	5

	5	2	×	6

	4	4	×	4

1	0	6	×	9

b)

	4	4	2	×	2

	2	0	8	×	7

	4	0	7	×	3

	3	0	5	×	0

c)

	2	0	7	×	9

	1	1	6	×	6

	2	7	5	×	1

	3	0	7	×	6

a)

			×	2	
8	2	6			

			×	3	
9	6	3			

2	3	4	×		
4	6	8			

1	0	6	×		
6	3	6			

b)

			×	3	
6	1	2			

			×	4	
8	6	4			

1	3	5	×		
2	7	0			

2	1	7	×		
8	6	8			

c)

			×	4	
6	0	8			

			×	5	
8	5	5			

1	5	1	×		
9	0	6			

1	8	3	×		
5	4	9			

a)

2	3	×	2
			0

3	2	×	3
			6

b)

	2	3	×	<input type="text"/>
8				2

	6	×	5
8			0

c)

3		×	3
	4		2

	8	×	6
4			8

d)

	9	×	<input type="text"/>
9	8		1

	8	×	<input type="text"/>
6	3		4



Time (seconds)	1	2	5	0	4	10
Distance (mm)	217					